

# TECHNICAL INFORMATION

## OCTANORM CLEANROOM SYSTEMS

### PHARMACEUTICAL AND MEDICAL ENGINEERING

#### Wall systems with wall cladding

Technical data sheet

Wall system P90

Wall system P98

THE  
WORLD  
OF  
SYSTEMS

**OCTANORM** 





# TECHNICAL DATA SHEET

## WALL TYPE P90

### Wall system with suspended steel sheet lagging

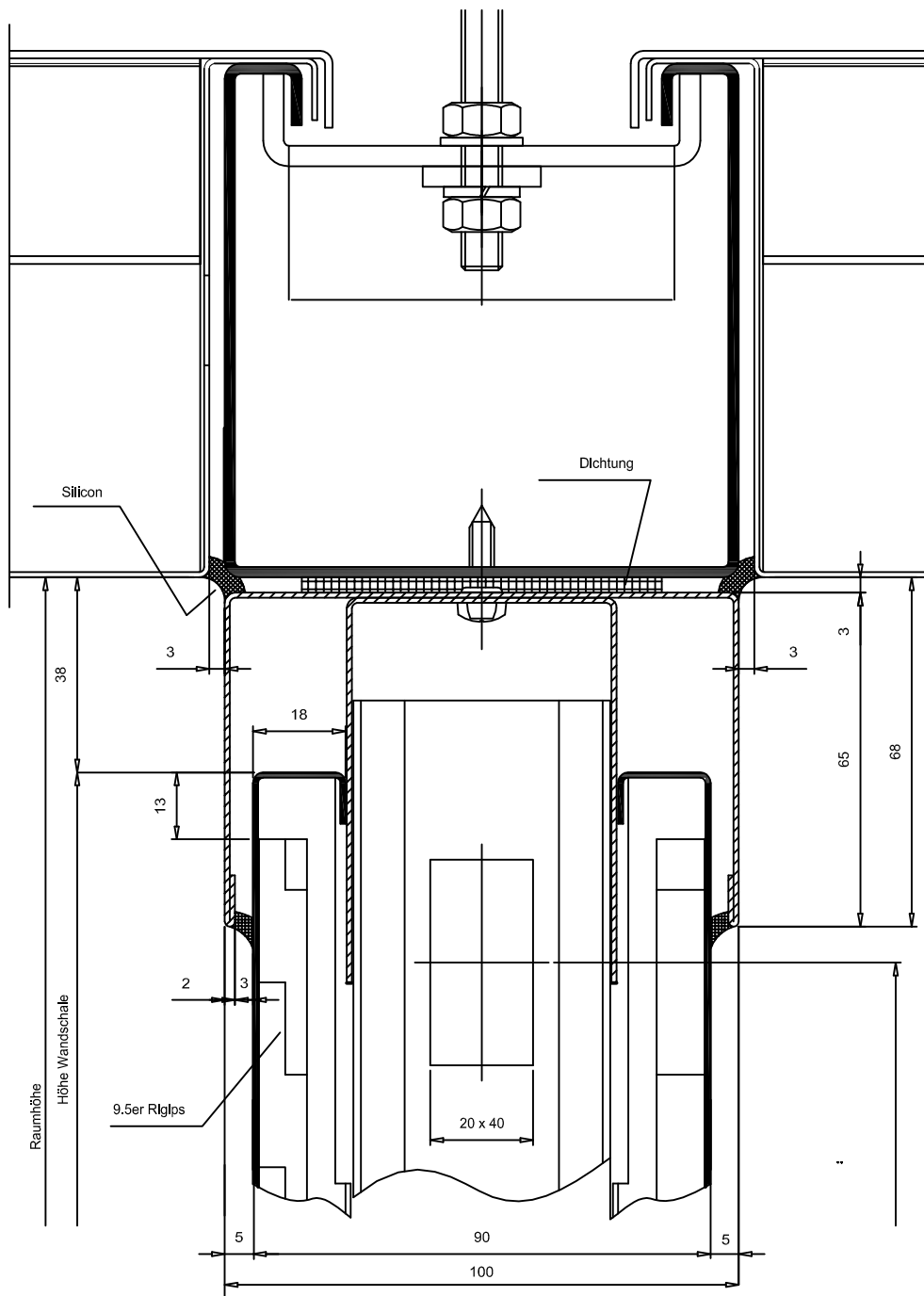
Surface of beam / extrusion	steel, blank
Surface of panels	Powder-coated or stainless steel, grinded
Panels	Steel sheet panel with plaster cardboard on the backside
Standard grid	1200 mm
Standard color	RAL 9010
Filling	none or on request
Wall height	2500 mm to 4500 mm, depends on grid size
Wall thickness	90 mm



Alle Toleranzen nach DIN ISO 2768 mittel		Material		
<small>This drawing is our literary property and may neither copied nor to be exposed approachable to third persons without our agreement; according to German Copyright Act</small>				
		Datum	Name	Description / Bezeichnung: D 005 Wand- Deckenanschluss an Bandraster
		Gezeichnet	24.07.2014 jk	
		Kontrolliert		
		Norm		
		Projekt Nr.		Z-Nr: VRS_P90_11_0001
		PRO_XXX		
Status	Änderungen	Datum	Name	<div style="text-align: right; font-size: 24pt; font-weight: bold;">1</div> <div style="text-align: right;">A4</div>

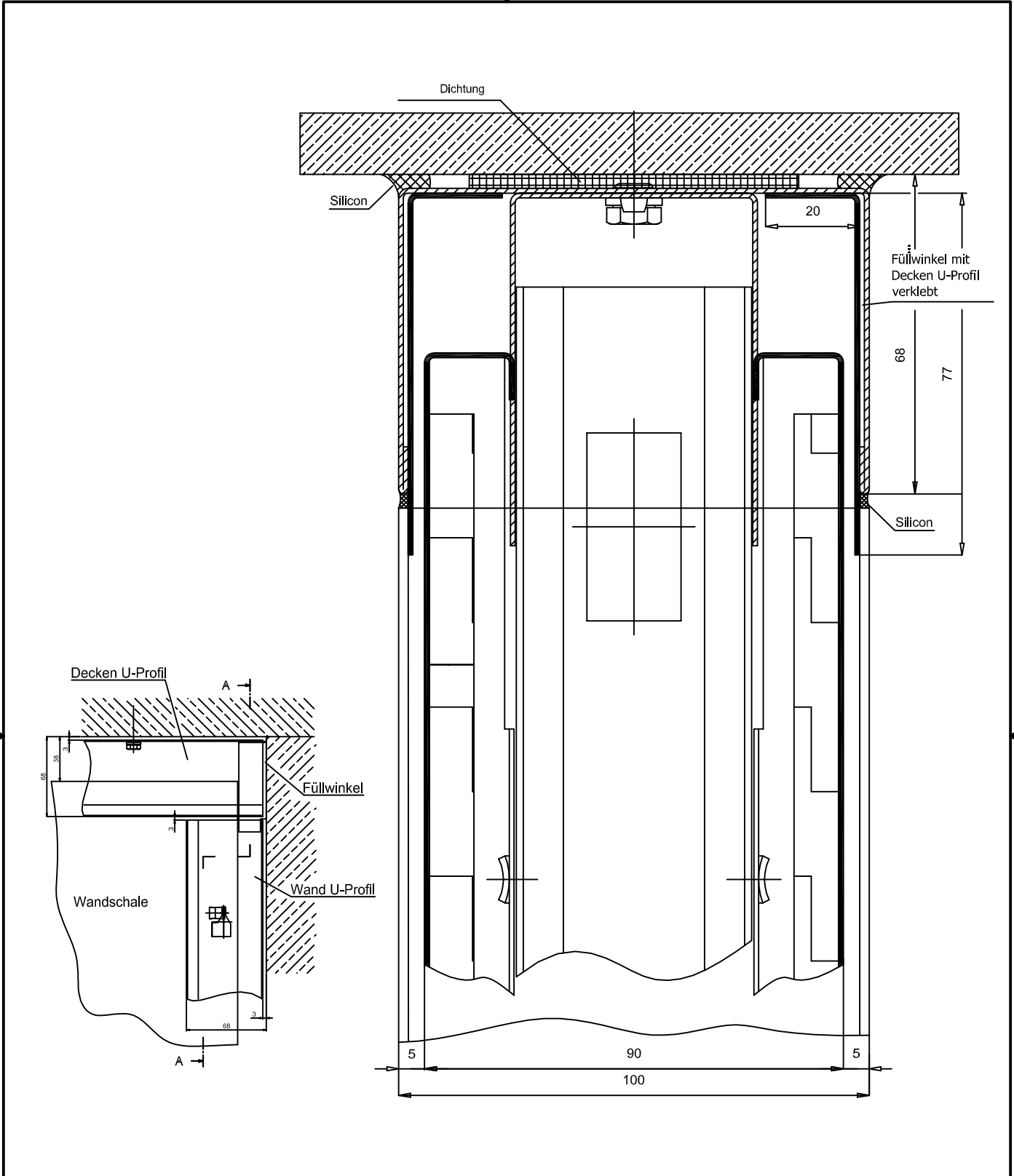

Alle Toleranzen nach DIN ISO 2768 mittel		Material		
<small>This drawing is our literary property and may neither copied nor to be exposed approachable to third persons without our agreement; according to German Copyright Act</small>				
		Datum	Name	Description / Bezeichnung: D 005 A Wand- Deckenanschluss Trennwand Voll
		Gezeichnet	24.07.2014 jk	
		Kontrolliert		
		Norm		
		Projekt Nr.		Z-Nr: VRS_P90_11_0002
		PRO_XXX		
Status	Änderungen	Datum	Name	1 A4

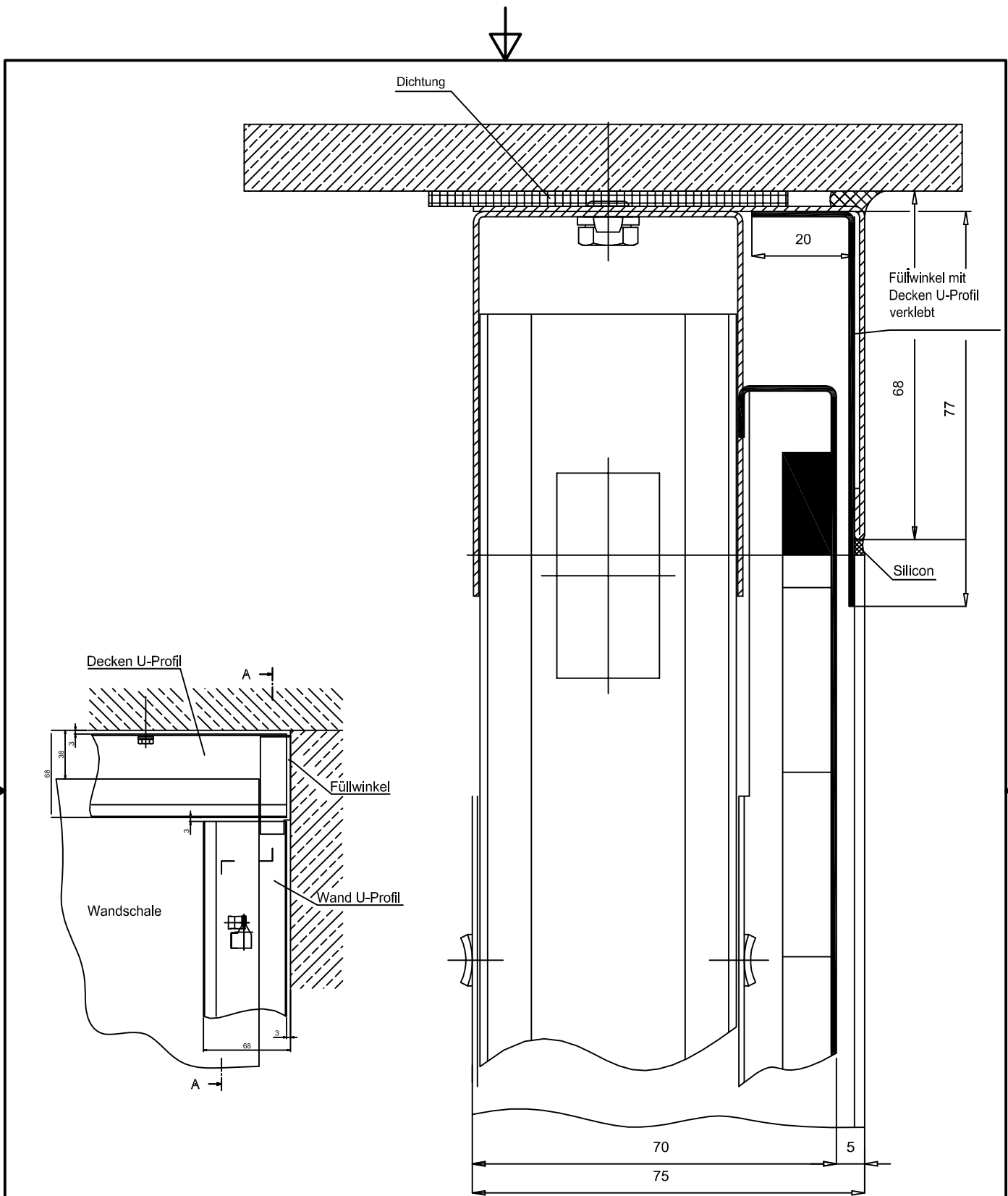

Alle Toleranzen nach DIN ISO 2768 mittel				Material		
This drawing is our literary property and may neither copied nor to be exposed approachable to third persons without our agreement; according to German Copyright Act						
			Datum	Name		Description / Bezeichnung: D 005 B Wand- Deckenanschluss Trennwand Wandschale
			Gezeichnet	24.07.2014	jk	
			Kontrolliert			
			Norm			
			Projekt Nr.			Z-Nr: VRS_P90_11_0003
			PRO_XXX			
Status	Änderungen	Datum	Name			1 A4

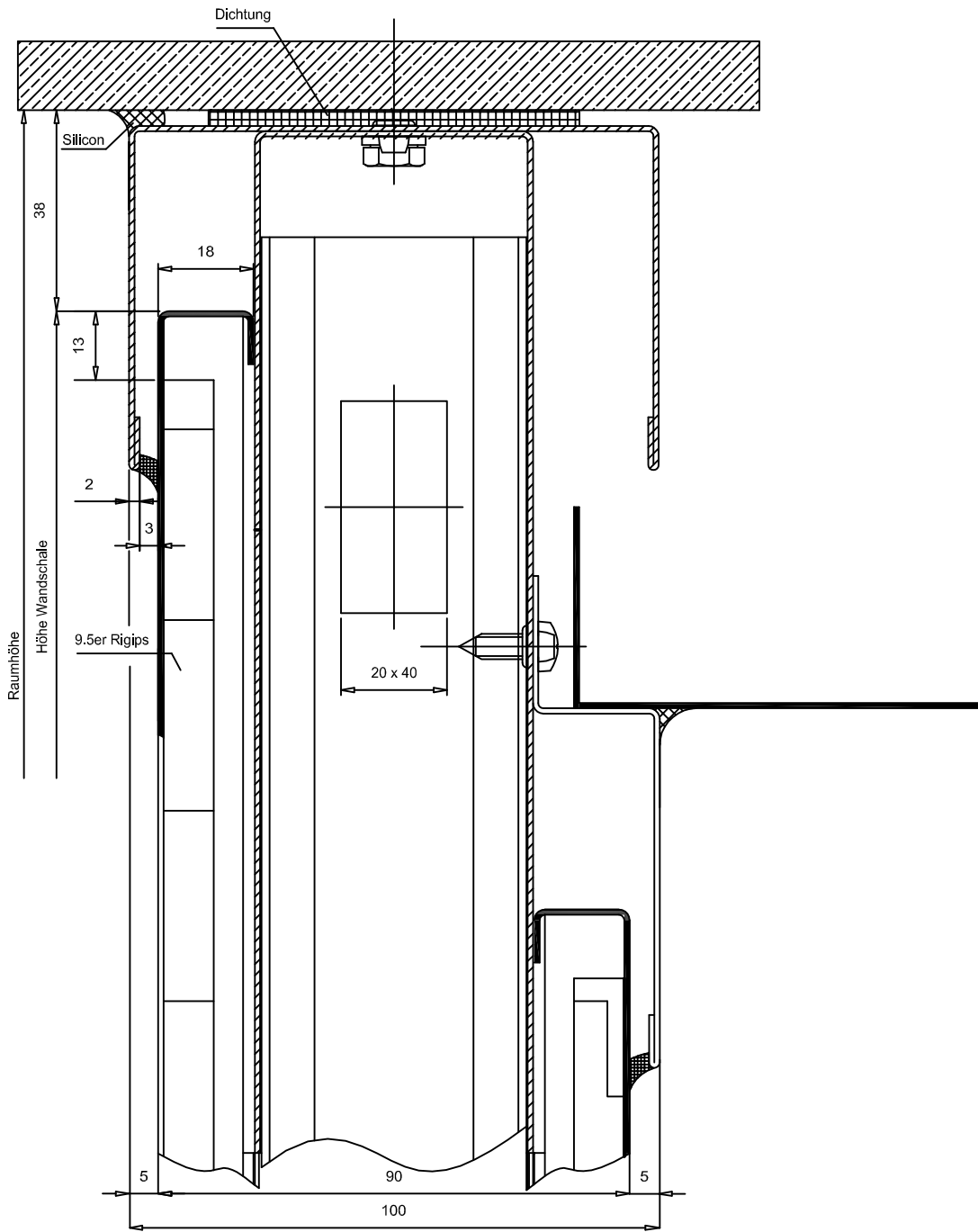

Alle Toleranzen nach DIN ISO 2768 mittel		Material		
This drawing is our literary property and may neither copied nor to be exposed approachable to third persons without our agreement; according to German Copyright Act				
		Datum	Name	Description / Bezeichnung: D 005 C Deckenanschluss mit Deckensprung
		Gezeichnet	24.07.2014 jk	
		Kontrolliert		
		Norm		
		Projekt Nr. PRO_XXX		Z-Nr: VRS_P90_11_0004
Status	Änderungen	Datum	Name	1 A4

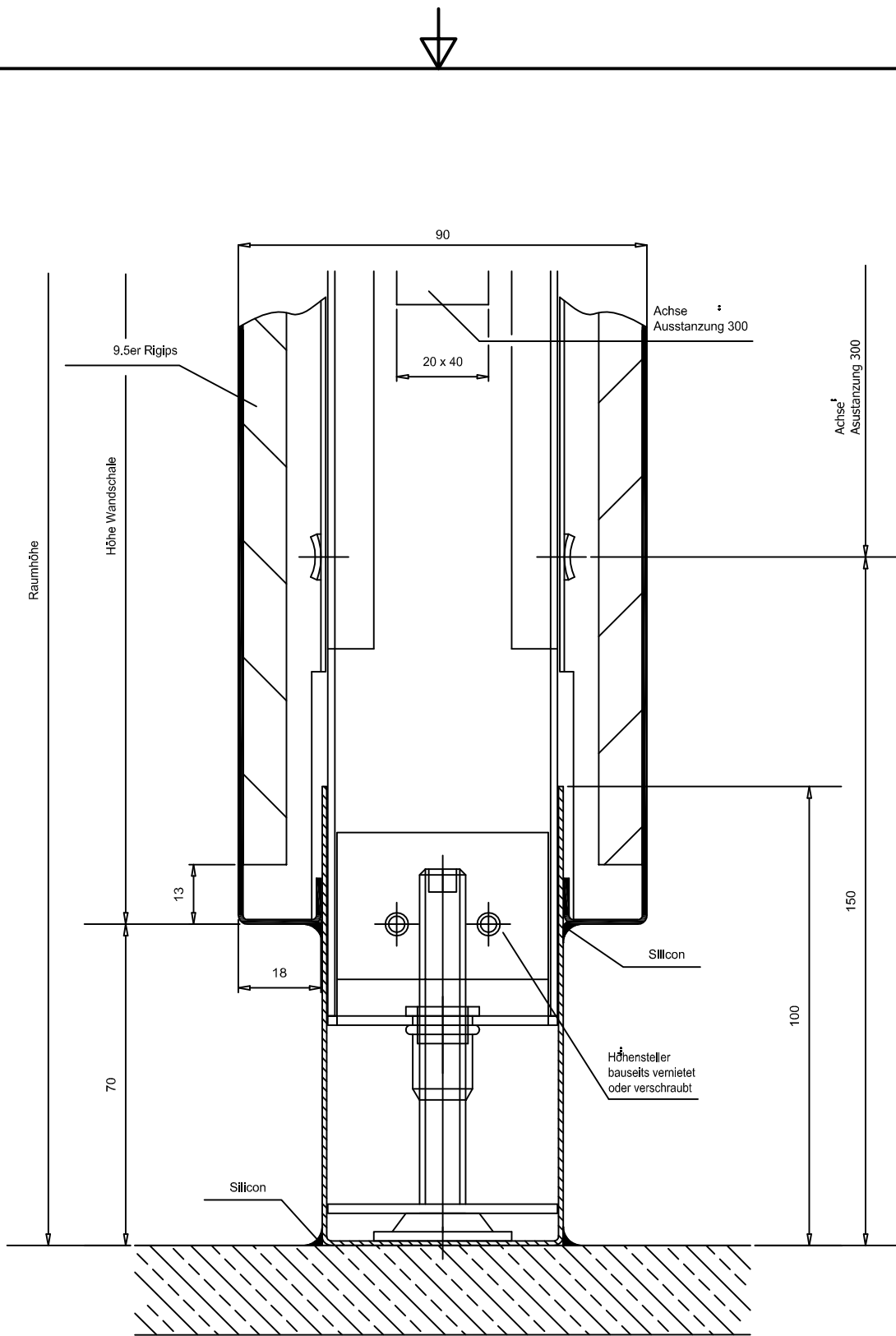

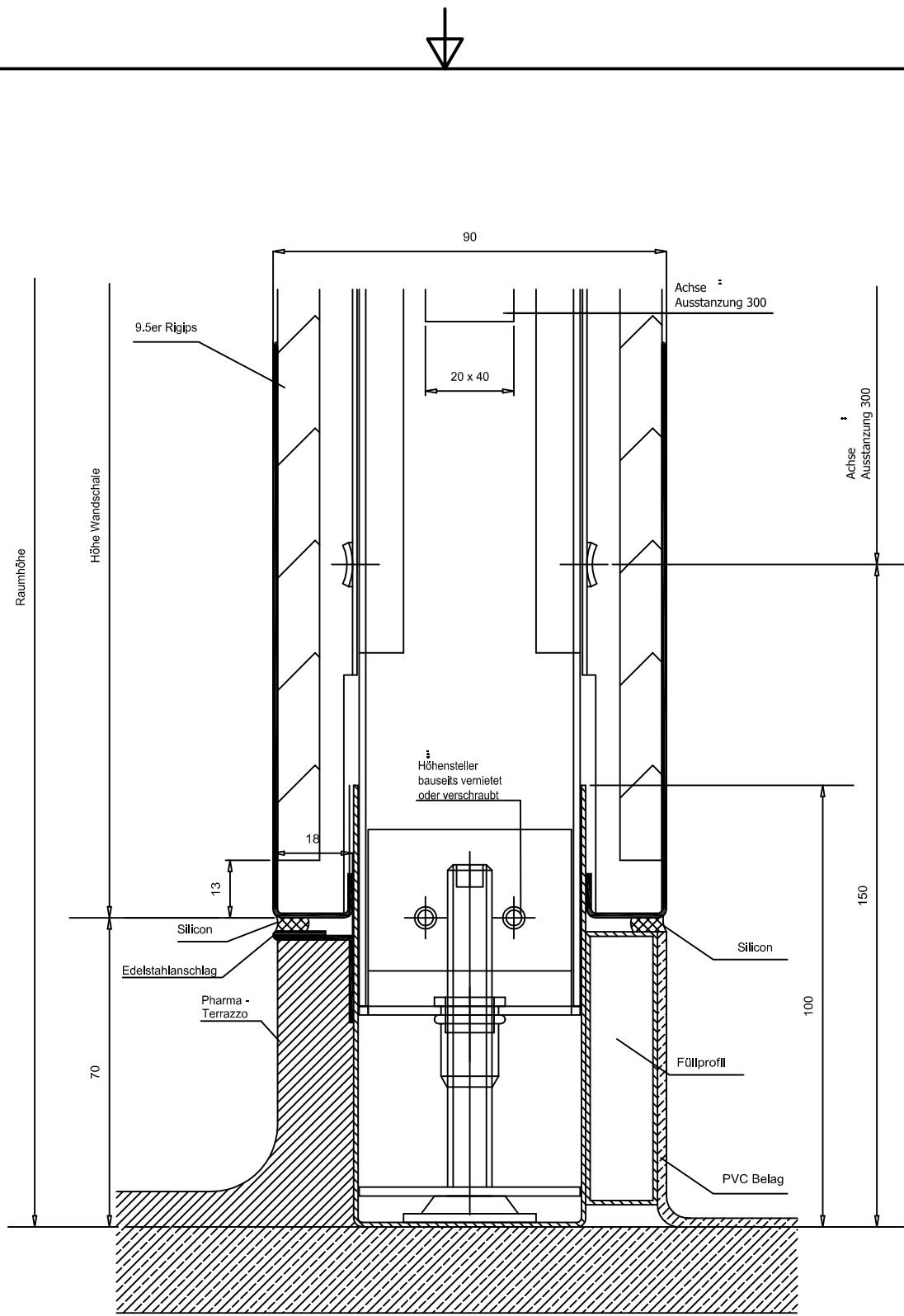

Alle Toleranzen nach DIN ISO 2768 mittel		Material		
<small>This drawing is our literary property and may neither copied nor to be exposed approachable to third persons without our agreement; according to German Copyright Act</small>				
		Datum	Name	Description / Bezeichnung: D 006 Sockelausbildung Wand-Bodenanschluss
		Gezeichnet	24.07.2014 jk	
		Kontrolliert		
		Norm		
		Projekt Nr.		Z-Nr: VRS_P90_11_0005
		PRO_XXX		
Status	Änderungen	Datum	Name	1 A4



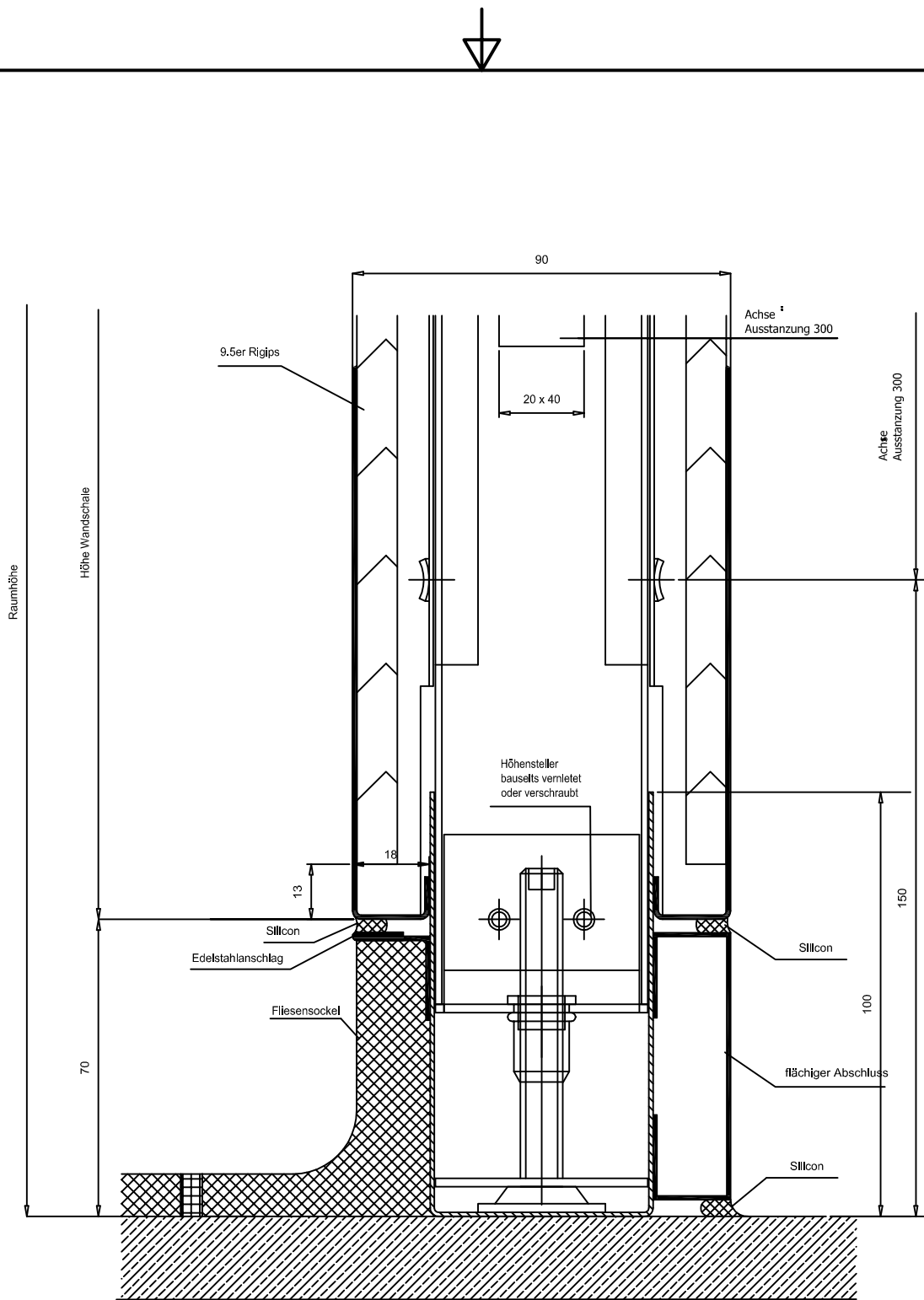

Alle Toleranzen nach DIN ISO 2768 mittel		Material		
<small>This drawing is our literary property and may neither copied nor to be exposed approachable to third persons without our agreement; according to German Copyright Act</small>				
		Datum	Name	Description / Bezeichnung: D 006 A Sockelausbildung Wand - Bodenanschluss Pharma - Terrazzo / PVC Belag
		Gezeichnet	24.07.2014 jk	
		Kontrolliert		
		Norm		
		Projekt Nr.		Z-Nr: VRS_P60_11_0006
		PRO_XXX		
Status	Änderungen	Datum	Name	1 A4





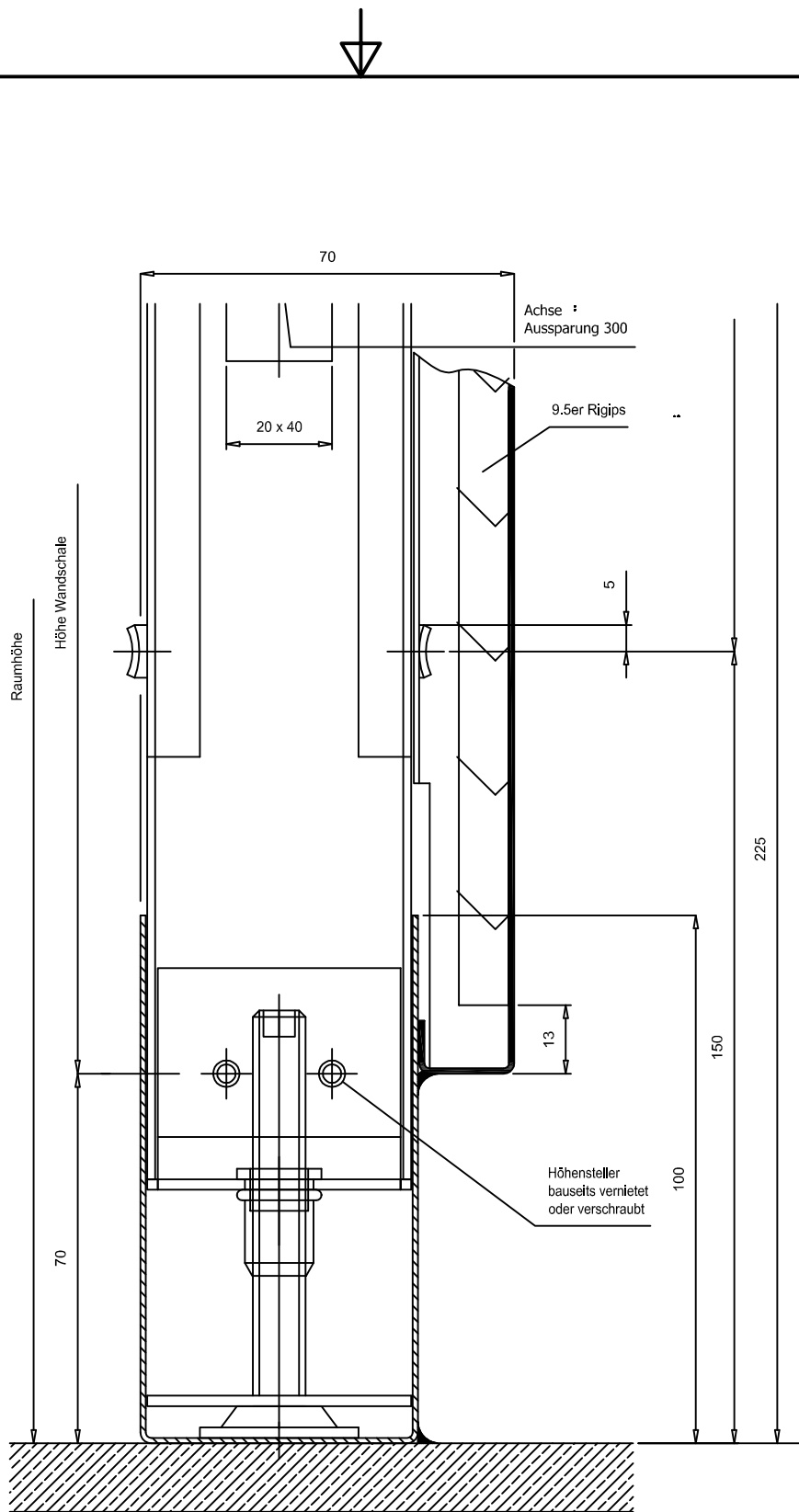

Alle Toleranzen nach DIN ISO 2768 mittel		Material		
<small>This drawing is our literary property and may neither copied nor to be exposed approachable to third persons without our agreement; according to German Copyright Act</small>				
		Datum	Name	Description / Bezeichnung: D 006 B Sockelausbildung Wand - Bodenanschluss Fliesenbelag/ flächiger Anschluss
		Gezeichnet	24.07.2014 jk	
		Kontrolliert		
		Norm		
		Projekt Nr.		Z-Nr: VRS_P60_11_0007
		PRO_XXX		
Status	Änderungen	Datum	Name	1
				A4

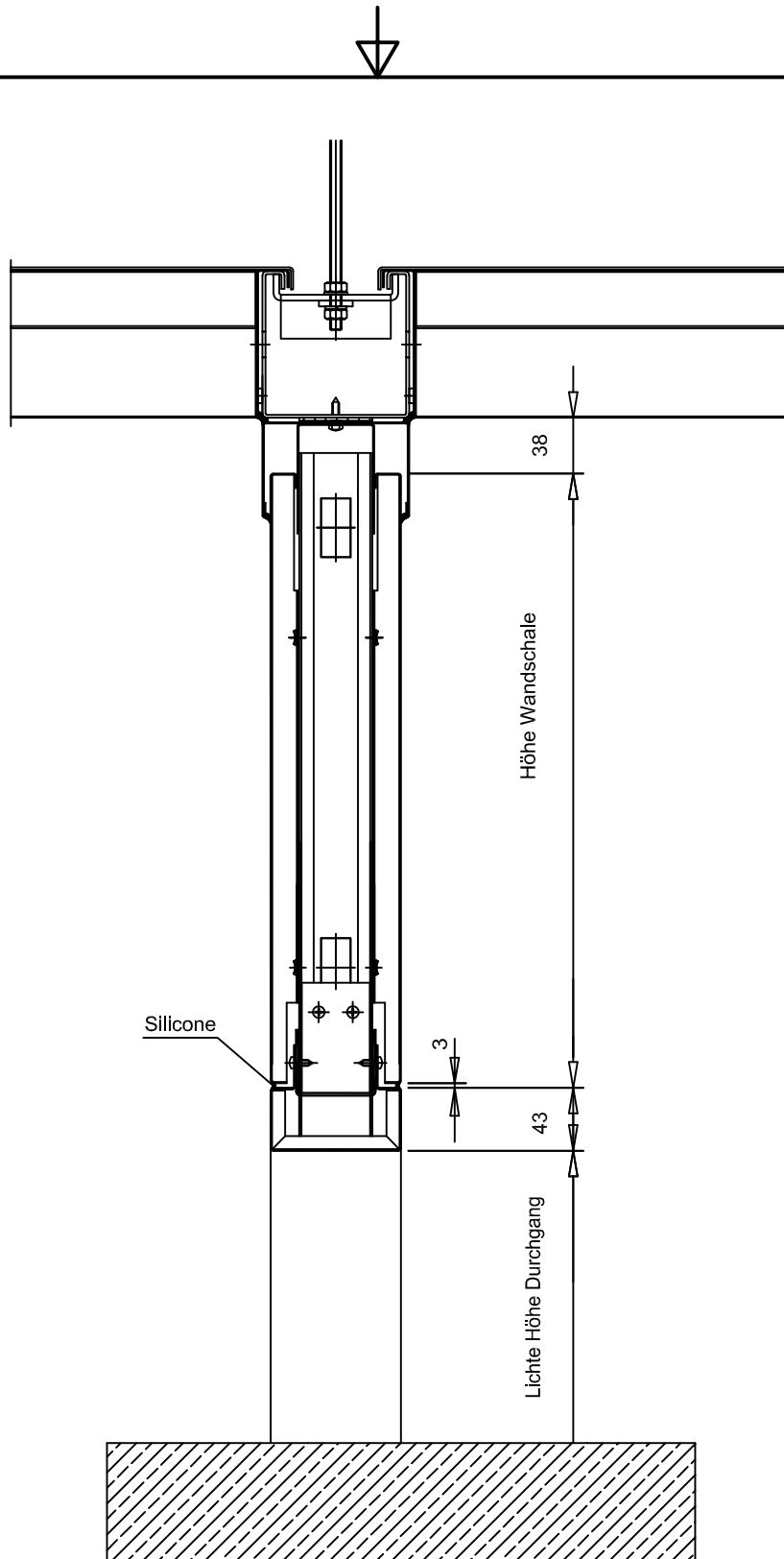

Alle Toleranzen nach DIN ISO 2768 mittel				Material			
This drawing is our literary property and may neither copied nor to be exposed approachable to third persons without our agreement; according to German Copyright Act							
			Datum	Name		Description / Bezeichnung: D 006 C Sockelausbildung halbe Wand Wand - Bodenanschluss	
			Gezeichnet	23.07.2014	jk		
			Kontrolliert				
			Norm				
			Projekt Nr.			Z-Nr: VRS_P60_11_0008	1
			PRO_XXX				
Status	Änderungen	Datum	Name				



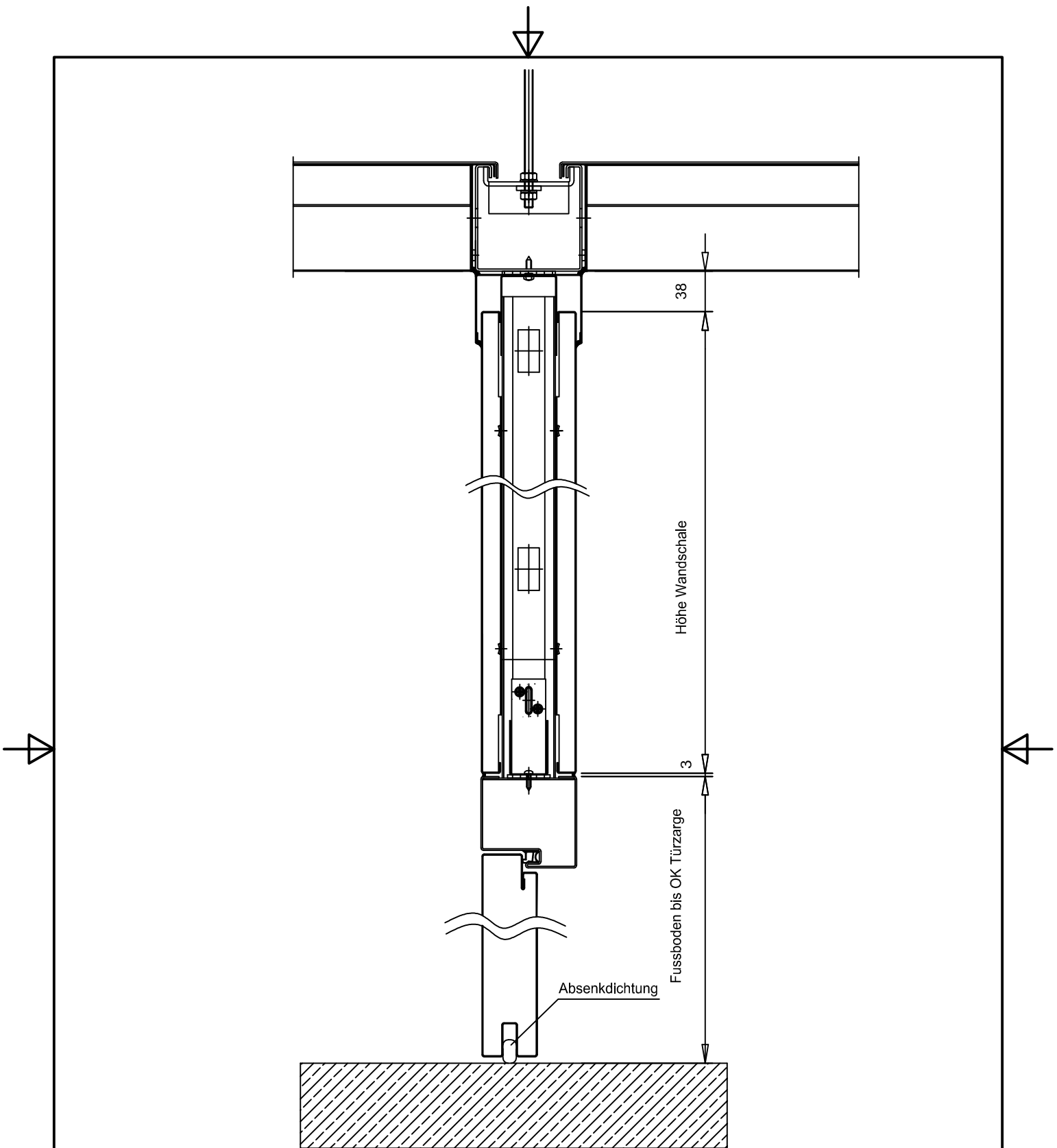

Alle Toleranzen nach DIN ISO 2768 mittel		Material			
This drawing is our literary property and may neither copied nor to be exposed approachable to third persons without our agreement; according to German Copyright Act					
		Datum	Name	Description / Bezeichnung: D 007 Durchgangsverkleidung Vertikalschnitt	
		Gezeichnet	24.07.2014 jk		
		Kontrolliert			
		Norm			
		Projekt Nr.		Z-Nr: VRS_P90_11_0009	
		PRO_XXX			
Status	Änderungen	Datum	Name	1 A4	



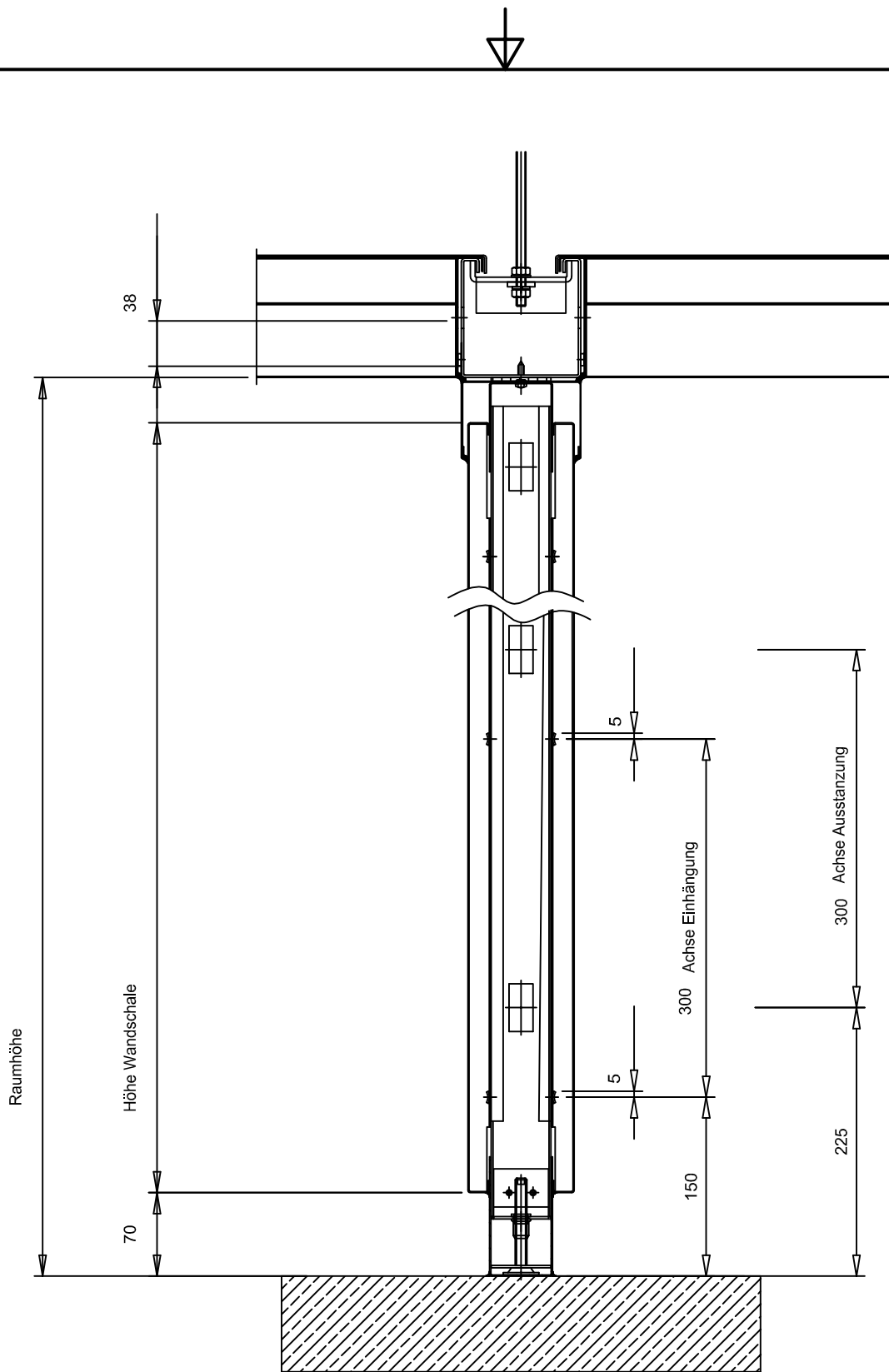

Alle Toleranzen nach DIN ISO 2768 mittel			Material		
This drawing is our literary property and may neither copied nor to be exposed approachable to third persons without our agreement; according to German Copyright Act					
			Datum	Name	Description / Bezeichnung: D 007 B Vertikalschnitt Trennwand Tür
			Gezeichnet	24.07.2014 jk	
			Kontrolliert		
			Norm		
			Projekt Nr. PRO_XXX		Z-Nr: VRS_P90_11_0011
					1
					A4
Status	Änderungen	Datum	Name		





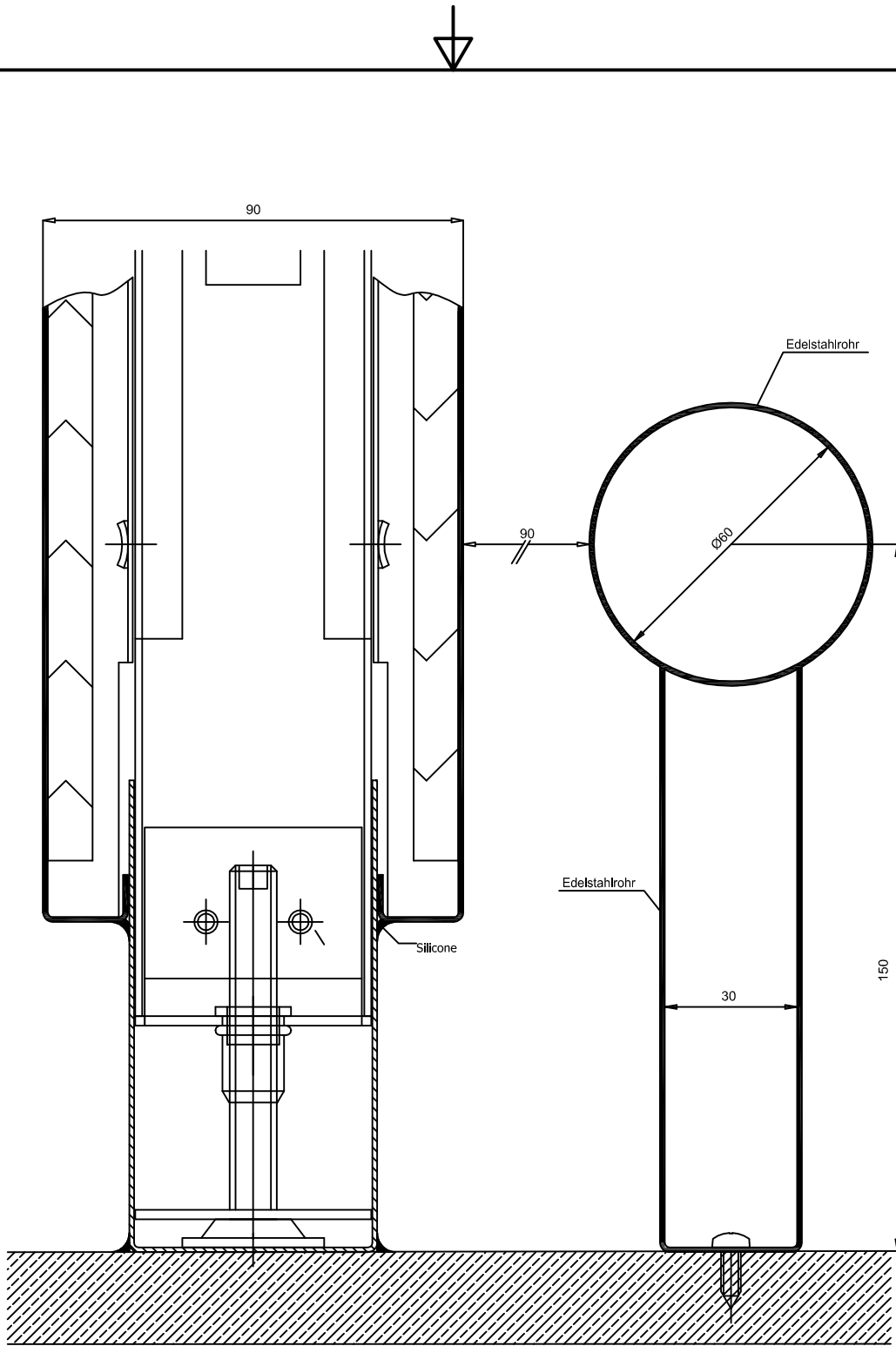

Alle Toleranzen nach DIN ISO 2768 mittel			Material		
This drawing is our literary property and may neither copied nor to be exposed approachable to third persons without our agreement; according to German Copyright Act					
			Datum	Name	Description / Bezeichnung: D 007 C Vertikalschnitt Trennwand Voll
			Gezeichnet	24.07.2014 jk	
			Kontrolliert		
			Norm		
			Projekt Nr. PRO_XXX		Z-Nr: VRS_P90_11_0012
Status	Änderungen	Datum	Name		1 A4

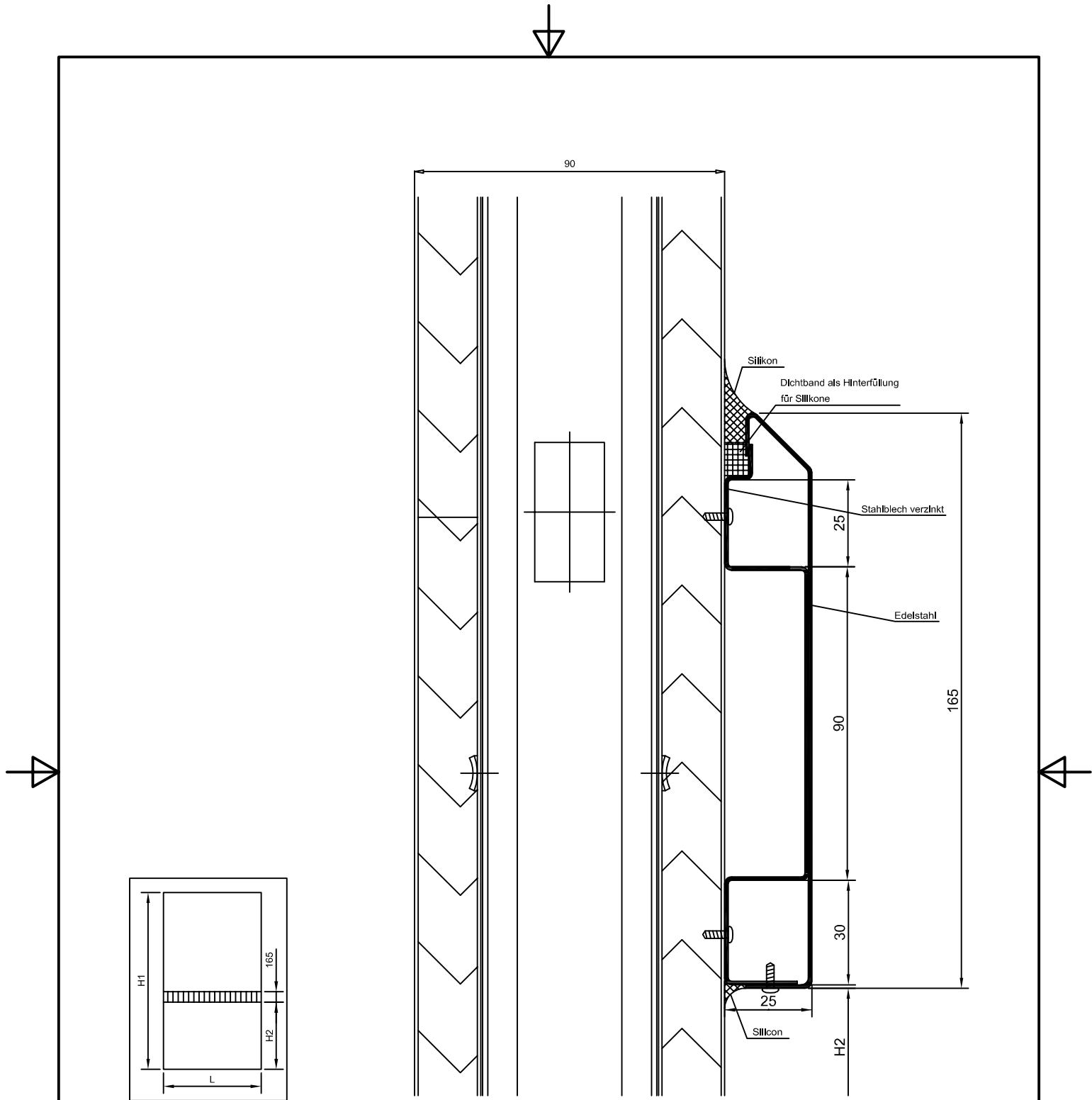

Alle Toleranzen nach DIN ISO 2768 mittel				Material			
This drawing is our literary property and may neither copied nor to be exposed approachable to third persons without our agreement; according to German Copyright Act							
				Datum	Name	Description / Bezeichnung: D 008 RammschutzFreistehend	
				Gezeichnet	25.07.2014		jk
				Kontrolliert			
				Norm			
				Projekt Nr. PRO_XXX		Z-Nr: VRS_P90_11_0013	
						1	
						A4	
Status	Änderungen	Datum	Name				



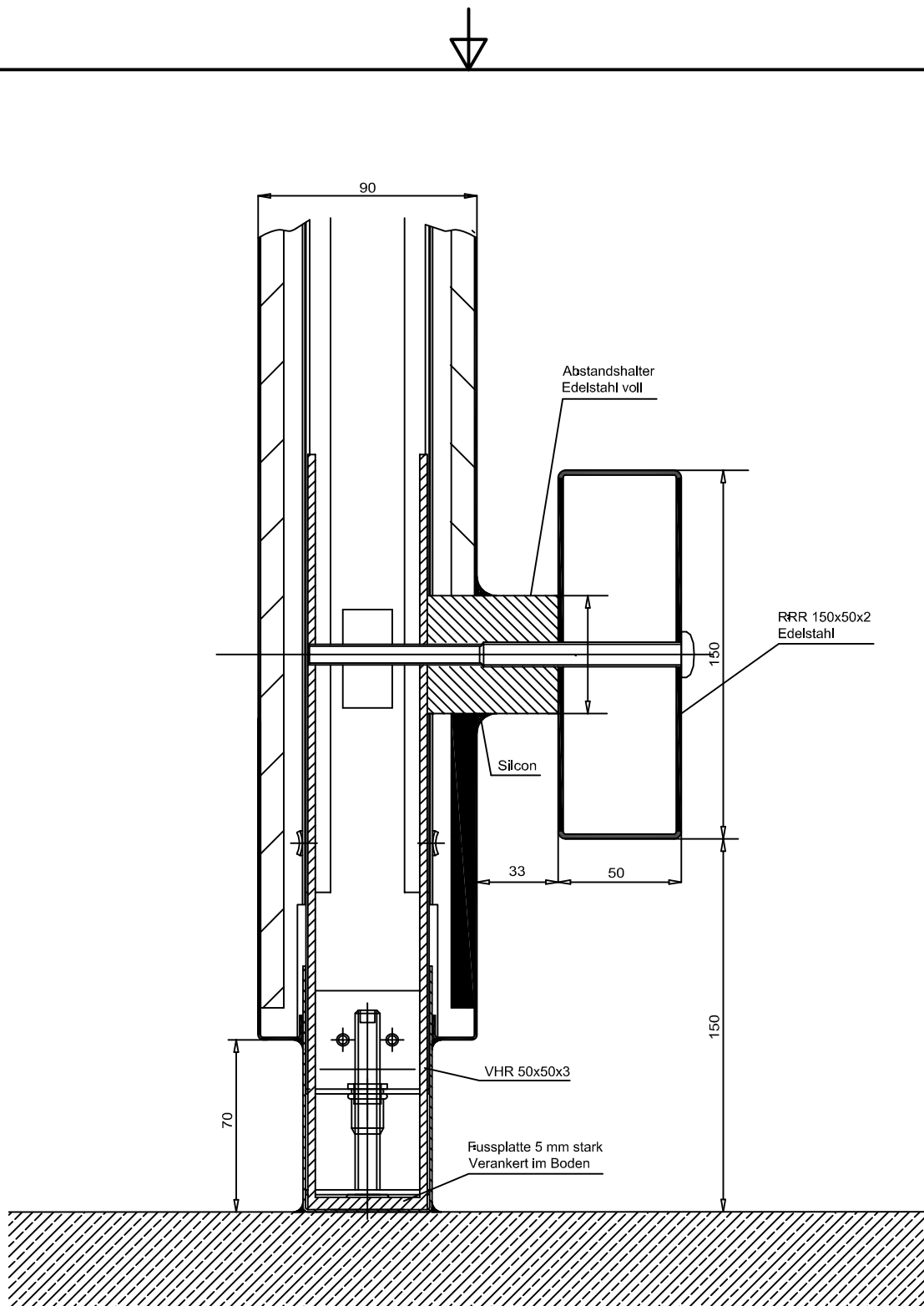

Alle Toleranzen nach DIN ISO 2768 mittel		Material					
This drawing is our literary property and may neither copied nor to be exposed approachable to third persons without our agreement; according to German Copyright Act						Description / Bezeichnung:	
		Datum	Name	D 008 A Schrammschutz			
		Gezeichnet	25.07.2014 jk				
		Kontrolliert					
		Norm		Z-Nr: VRS_P90_11_0014 <table border="1" style="float: right;"> <tr> <td>1</td> </tr> <tr> <td>A4</td> </tr> </table>		1	A4
1							
A4							
		Projekt Nr. PRO_XXX					
Status	Änderungen	Datum	Name				



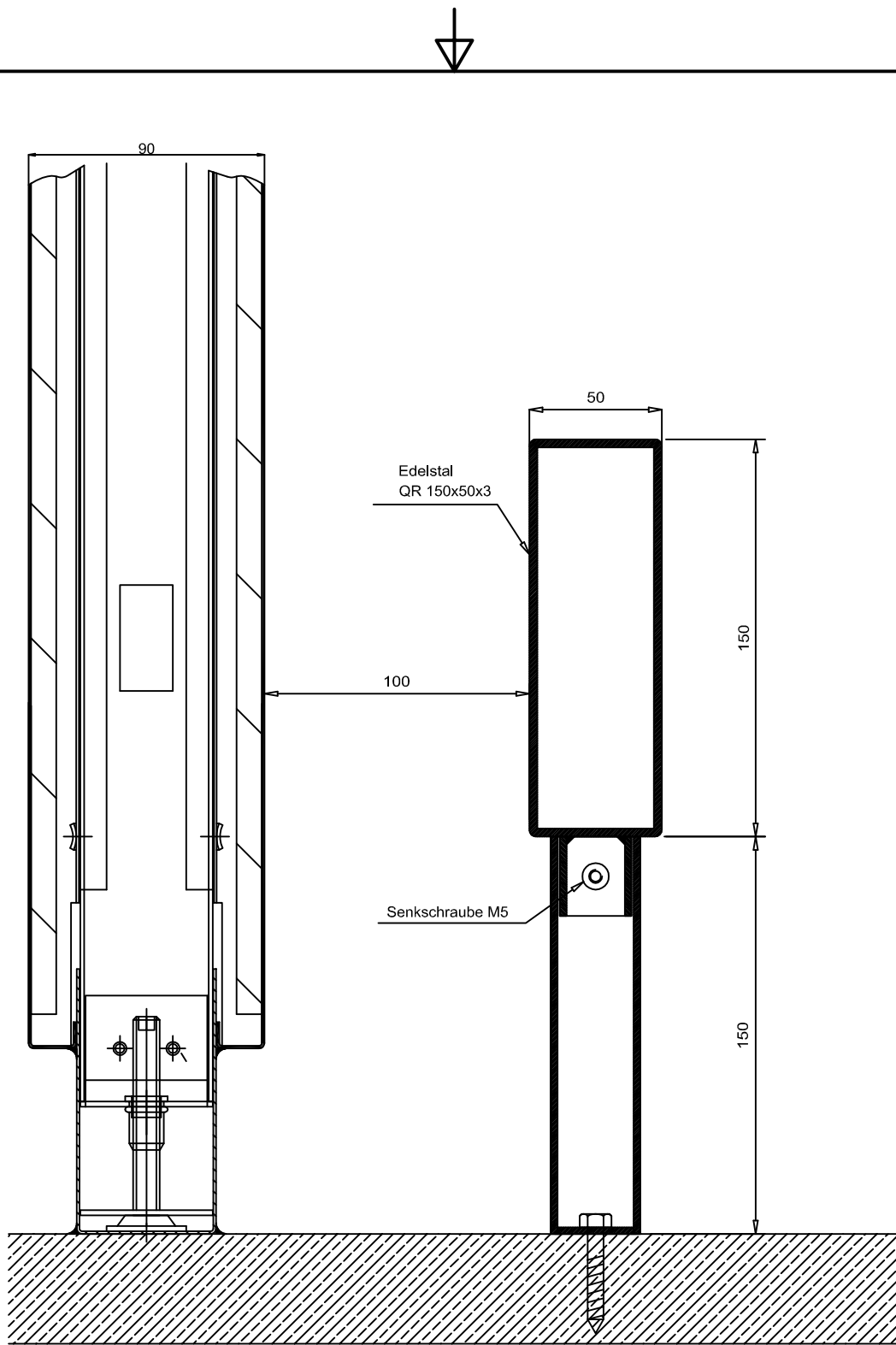

Alle Toleranzen nach DIN ISO 2768 mittel				Material			
This drawing is our literary property and may neither copied nor to be exposed approachable to third persons without our agreement; according to German Copyright Act							
			Datum	Name		Description / Bezeichnung: D 008 B Rammschutz an Reinraumwand	
			Gezeichnet	25.07.2014	jk		
			Kontrolliert				
			Norm				
			Projekt Nr. PRO_XXX			Z-Nr: VRS_P90_11_0015	1
Status	Änderungen	Datum	Name			A4	





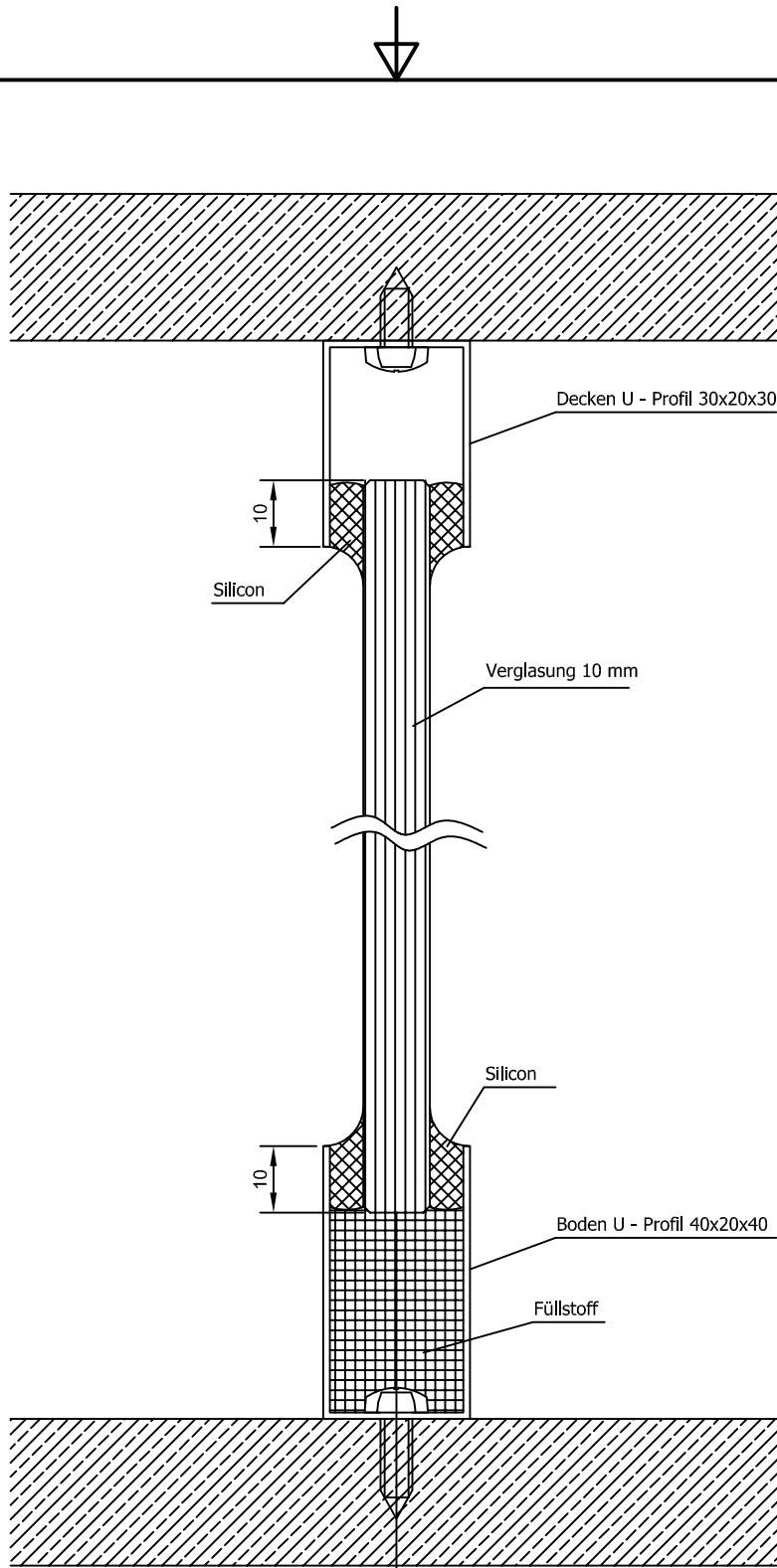

Alle Toleranzen nach DIN ISO 2768 mittel				Material			
This drawing is our literary property and may neither copied nor to be exposed approachable to third persons without our agreement; according to German Copyright Act							
			Datum	Name		Description / Bezeichnung: D 008 C Rammschutz freistehend rechteckig	
			Gezeichnet	25.07.2014	jk		
			Kontrolliert				
			Norm				
			Projekt Nr. PRO_XXX			Z-Nr: VRS_P90_11_0016	1
Status	Änderungen	Datum	Name			A4	

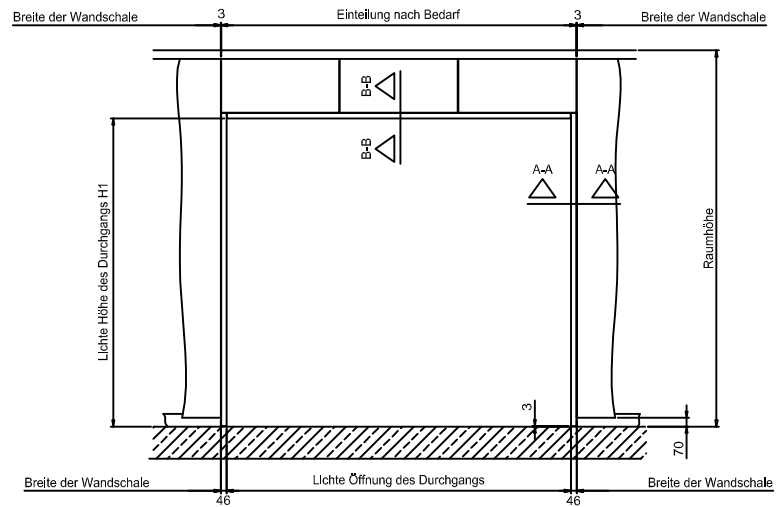
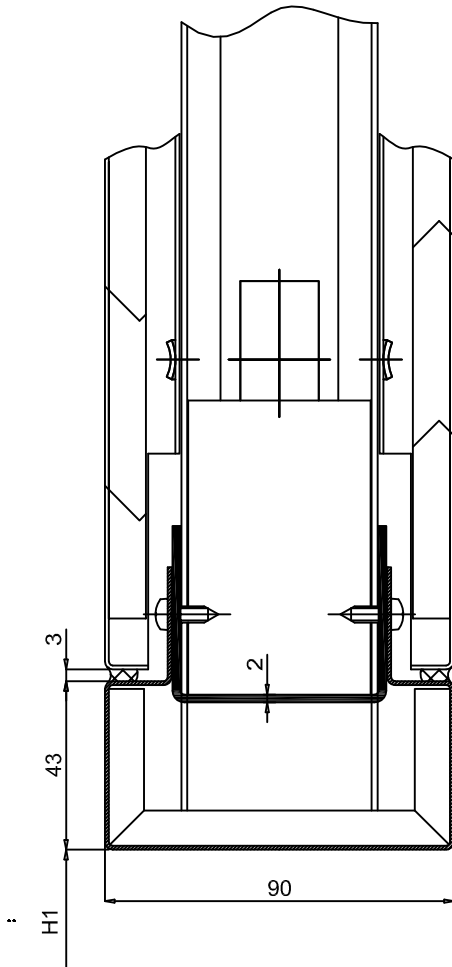

Alle Toleranzen nach DIN ISO 2768 mittel			Material		
This drawing is our literary property and may neither copied nor to be exposed approachable to third persons without our agreement; according to German Copyright Act					
			Datum	Name	Description / Bezeichnung: D 009 Glaswand
			Gezeichnet	25.07.2014 jk	
			Kontrolliert		
			Norm		
			Projekt Nr. PRO_XXX		Z-Nr: VRS_P90_11_0017
					1
					A4
Status	Änderungen	Datum	Name		

# Schnitt B-B



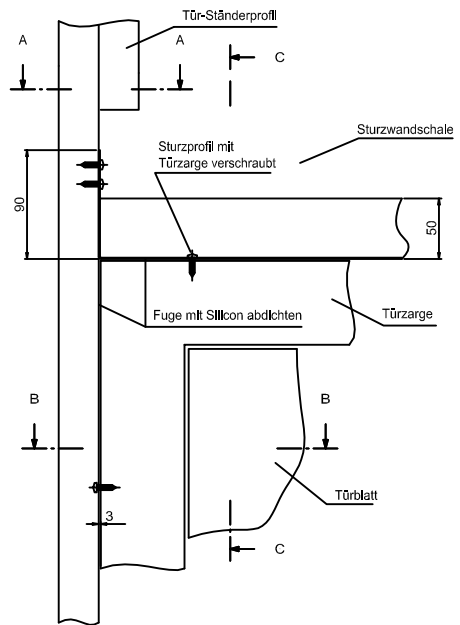
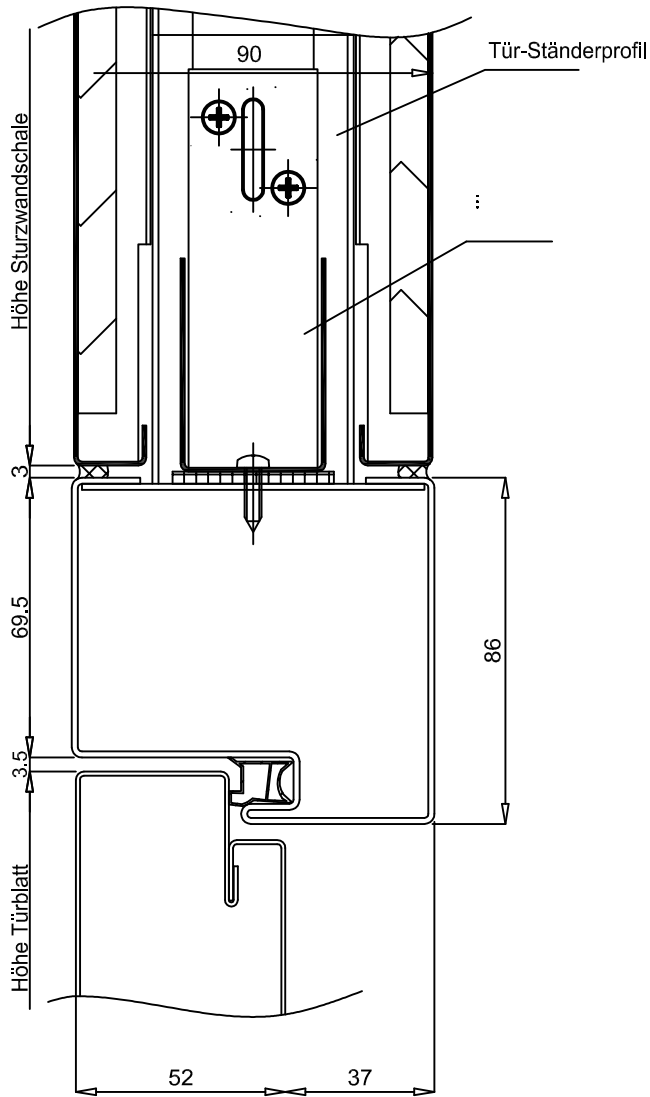

Alle Toleranzen nach DIN ISO 2768 mittel				Material			
This drawing is our literary property and may neither copied nor to be exposed approachable to third persons without our agreement; according to German Copyright Act							
				Datum	Name	Description / Bezeichnung: D 010 Durchgangszarge	
				Gezeichnet	25.07.2014		jk
				Kontrolliert			
				Norm			
				Projekt Nr. PRO_XXX		Z-Nr: VRS_P90_11_0018	
						1	
						A4	
Status	Änderungen	Datum	Name				

# Schnitt C-C

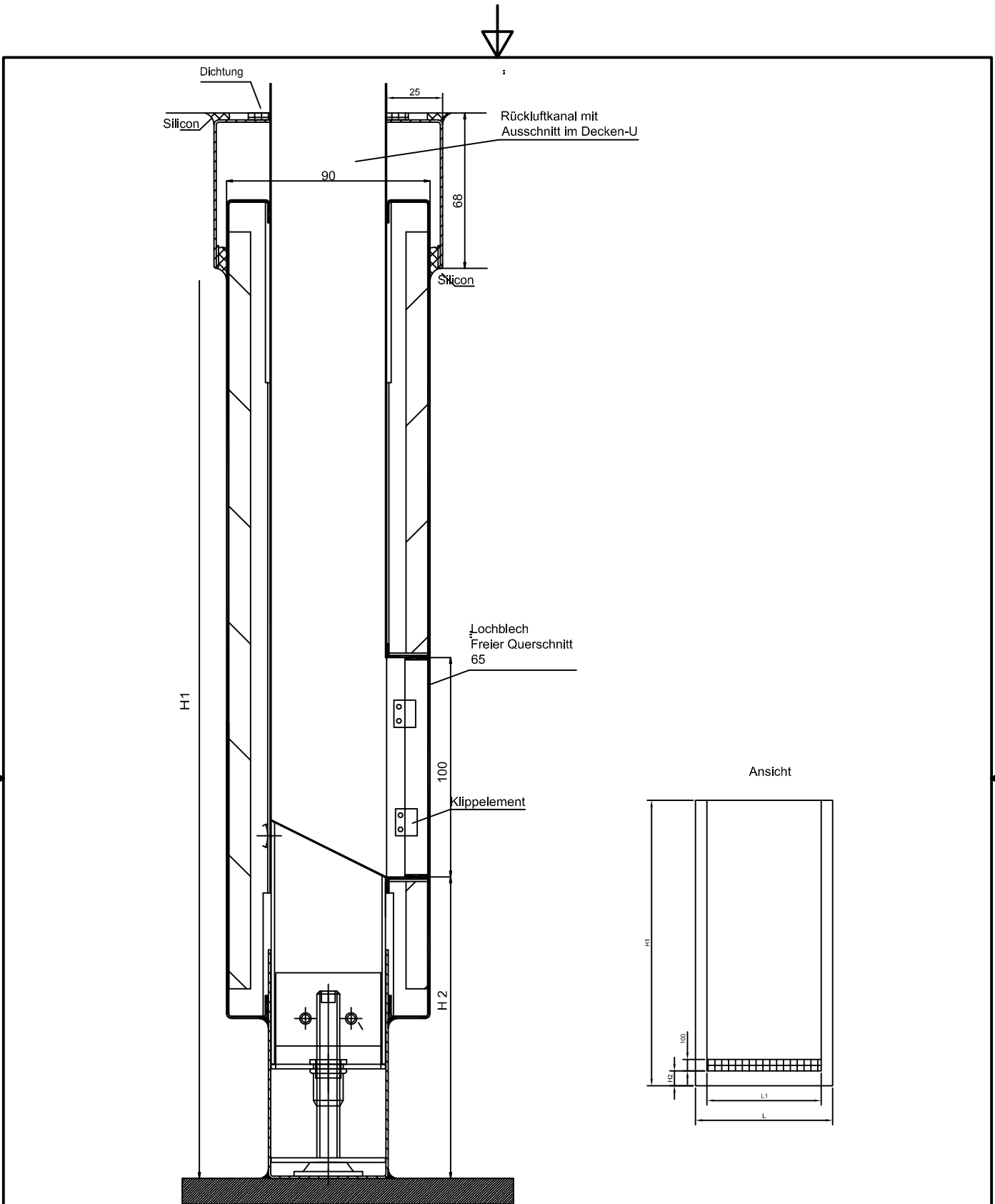

Alle Toleranzen nach DIN ISO 2768 mittel		Material		
<small>This drawing is our literary property and may neither copied nor to be exposed approachable to third persons without our agreement; according to German Copyright Act</small>				
		Datum	Name	Description / Bezeichnung: D 012 Türanschluss an Vollwand
		Gezeichnet	25.07.2014 jk	
		Kontrolliert		
		Norm		
		Projekt Nr.		Z-Nr: VRS_P90_11_0019
		PRO_XXX		
Status	Änderungen	Datum	Name	1 A4



Alle Toleranzen nach DIN ISO 2768 mittel				Material			
This drawing is our literary property and may neither copied nor to be exposed approachable to third persons without our agreement; according to German Copyright Act							
				Datum	Name	Description / Bezeichnung: D 013 Rücklaufschaft integriert	
			Gezeichnet	25.07.2014	jk		
			Kontrolliert				
			Norm				
			Projekt Nr. PRO_XXX			Z-Nr: VRS_P90_11_0020	1
Status	Änderungen	Datum	Name			A4	

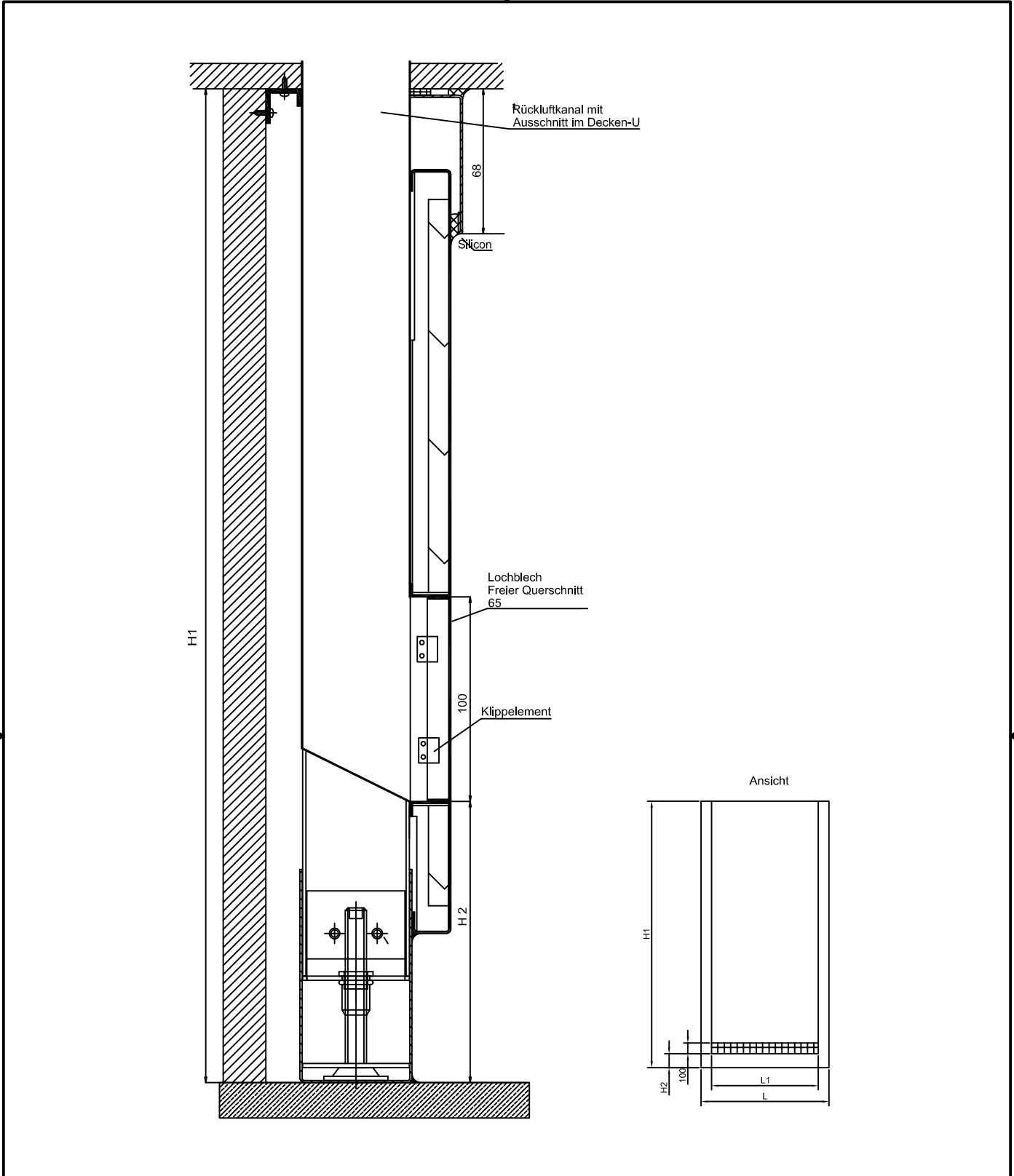

Alle Toleranzen nach DIN ISO 2768 mittel				Material			
This drawing is our literary property and may neither copied nor to be exposed approachable to third persons without our agreement; according to German Copyright Act							
			Datum	Name		Description / Bezeichnung: D 013 A Rücklaufschaft integriert mit Wandverkelidung	
			Gezeichnet	25.07.2014	jk		
			Kontrolliert				
			Norm				
			Projekt Nr. PRO_XXX			Z-Nr: VRS_P90_11_0021	1
Status	Änderungen	Datum	Name			A4	

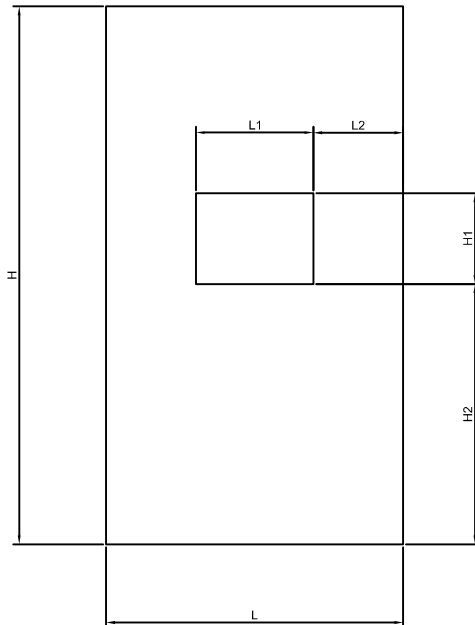
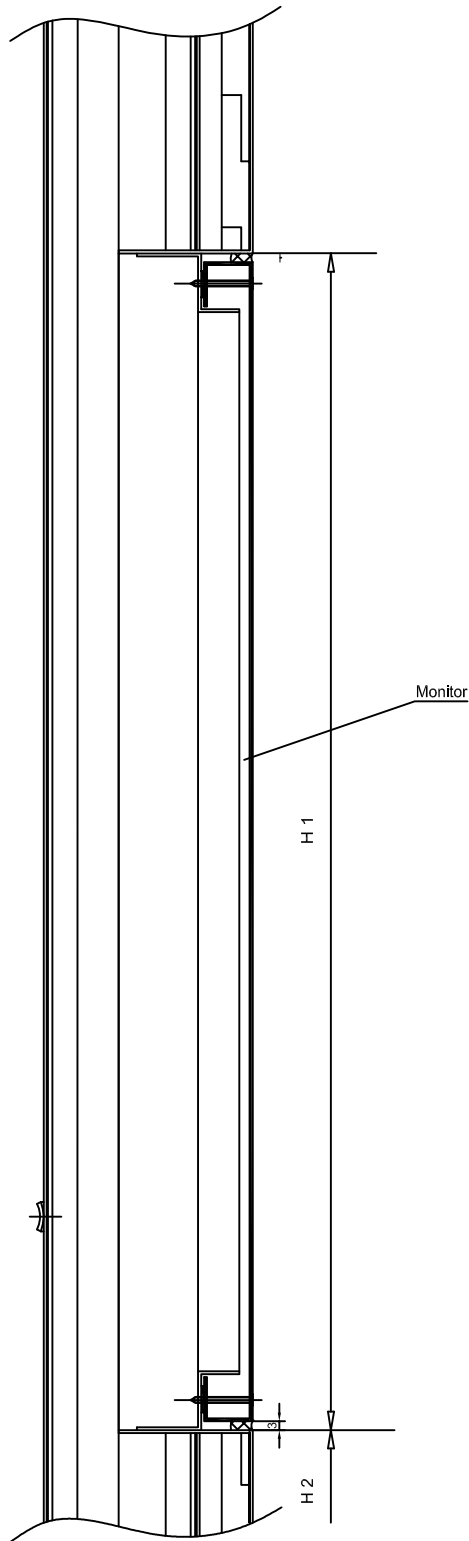

Alle Toleranzen nach DIN ISO 2768 mittel				Material		
This drawing is our literary property and may neither copied nor to be exposed approachable to third persons without our agreement; according to German Copyright Act						
				Datum	Name	Description / Bezeichnung: D 013 B Installation Trennwand halb
				Gezeichnet	25.07.2014 jk	
				Kontrolliert		
				Norm		
				Projekt Nr. PRO_XXX		Z-Nr: VRS_P90_11_0022
						1
						A4
Status	Änderungen	Datum	Name			

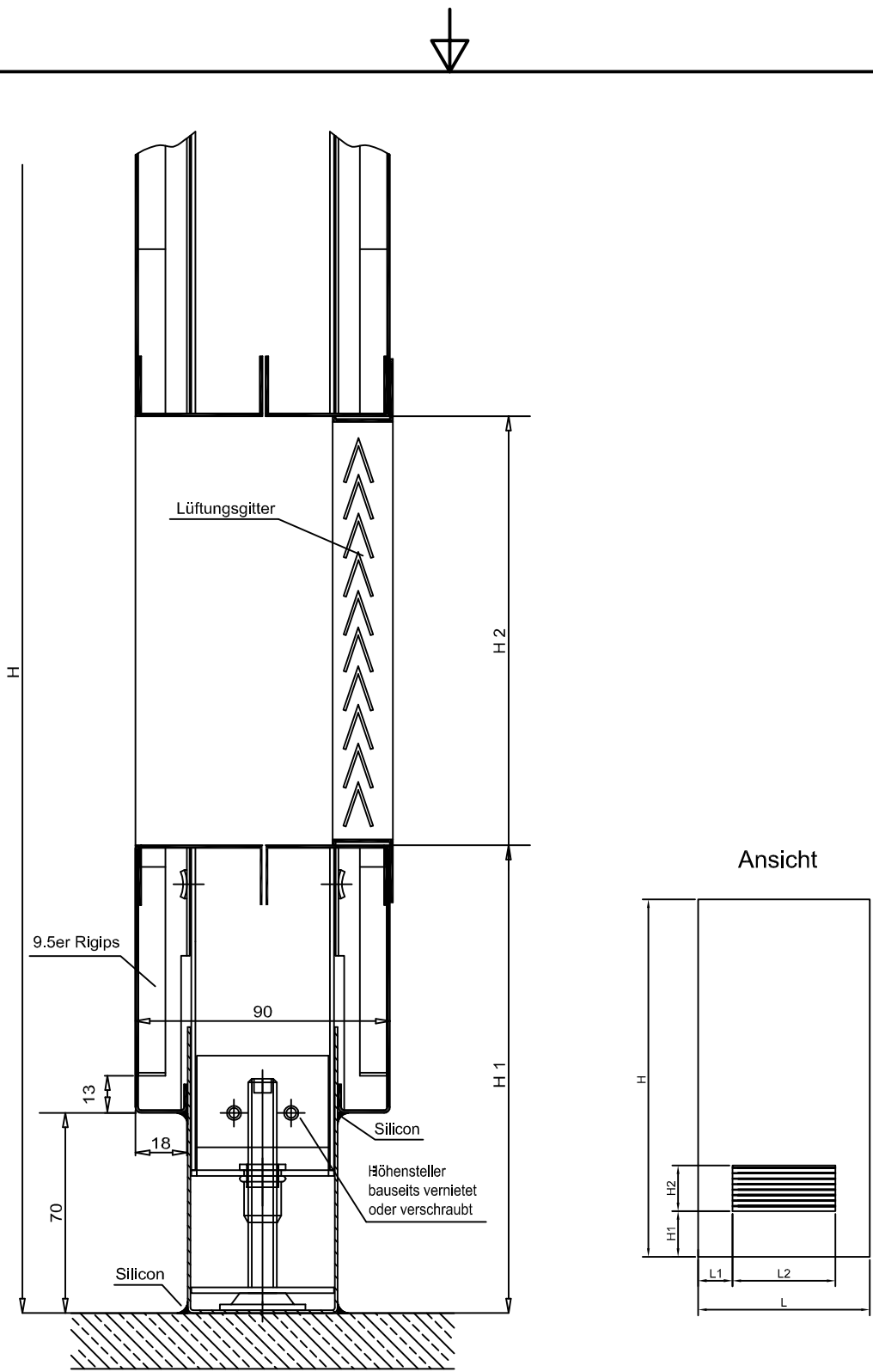

Alle Toleranzen nach DIN ISO 2768 mittel				Material		
<small>This drawing is our literary property and may neither copied nor to be exposed approachable to third persons without our agreement; according to German Copyright Act</small>						
			Datum	Name		Description / Bezeichnung: D 013 C Lüftungsgitter übergreifend
			Gezeichnet	25.07.2014	jk	
			Kontrolliert			
			Norm			
			Projekt Nr.			Z-Nr: VRS_P90_11_0023
			PRO_XXX			
Status	Änderungen	Datum	Name			1 A4





Schnitt B-B

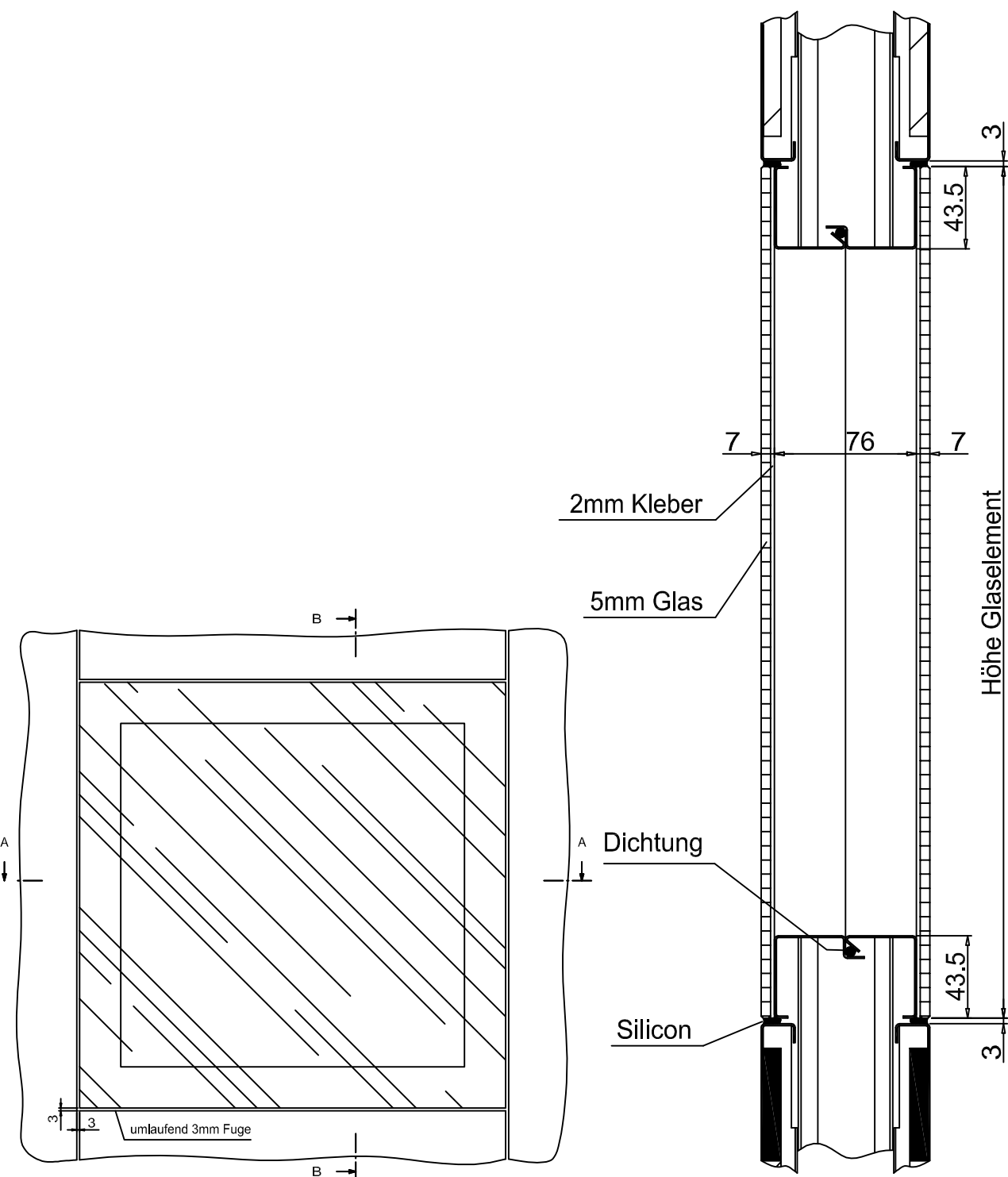

Alle Toleranzen nach DIN ISO 2768 mittel				Material	
This drawing is our literary property and may neither copied nor to be exposed approachable to third persons without our agreement; according to German Copyright Act					
			Datum	Name	
			Gezeichnet	25-07-2014	jk
			Kontrolliert		
			Norm		
			Projekt Nr.		
			PRO_XXX		
Status	Änderungen	Datum	Name		





Description / Bezeichnung:  
D 014 A Trennwandverglasung

Z-Nr: VRS\_P90\_11\_0024

1
A4

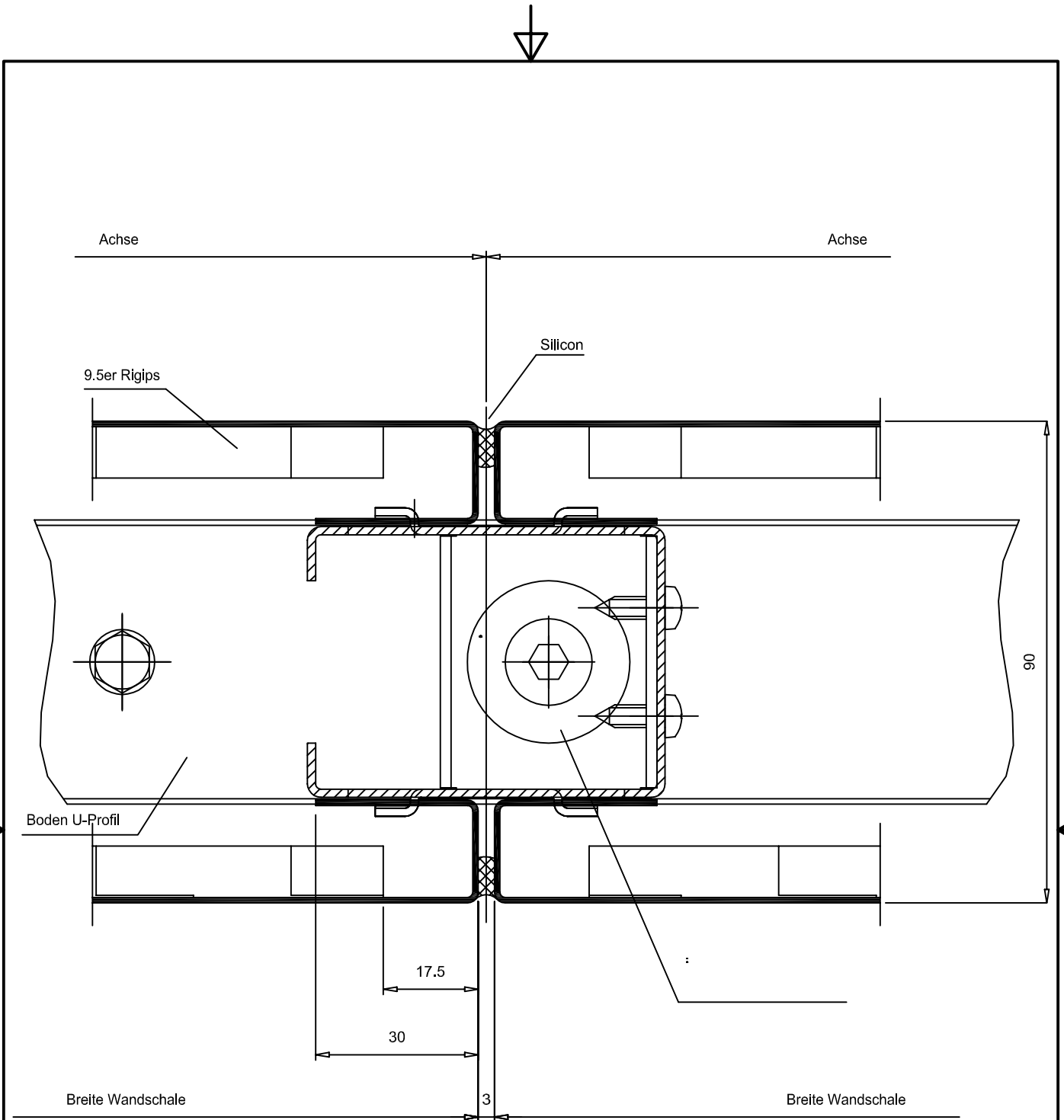



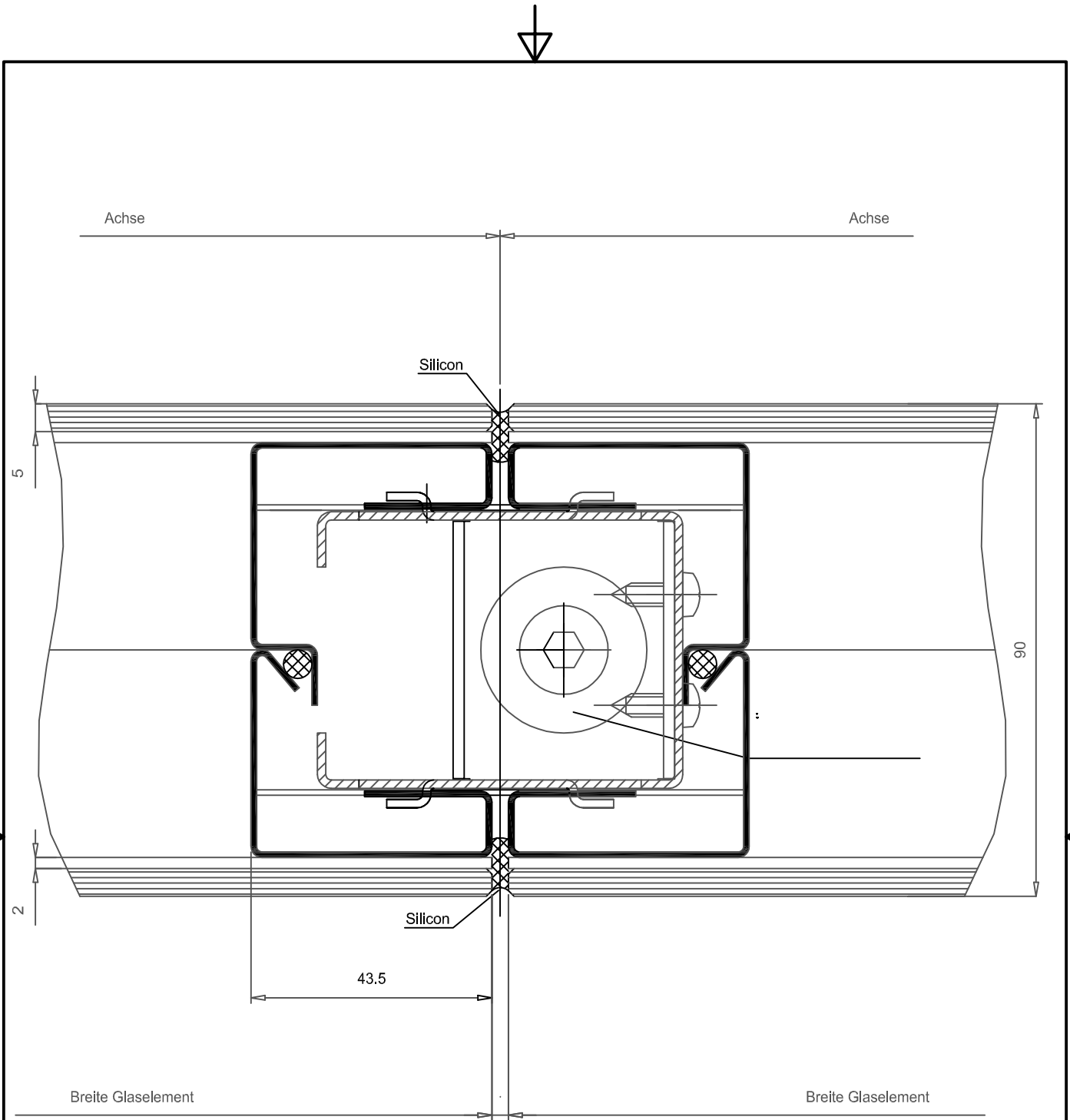

Alle Toleranzen nach DIN ISO 2768 mittel				Material			
This drawing is our literary property and may neither copied nor to be exposed approachable to third persons without our agreement; according to German Copyright Act							
				Datum	Name	Description / Bezeichnung: D 001 Trennwand voll	
				Gezeichnet	16.07.2014		jk
				Kontrolliert			
				Norm			
				Projekt Nr. PRO_XXX		Z-Nr: VRS_P90_12_0001	
						1	
						A4	
Status	Änderungen	Datum	Name				

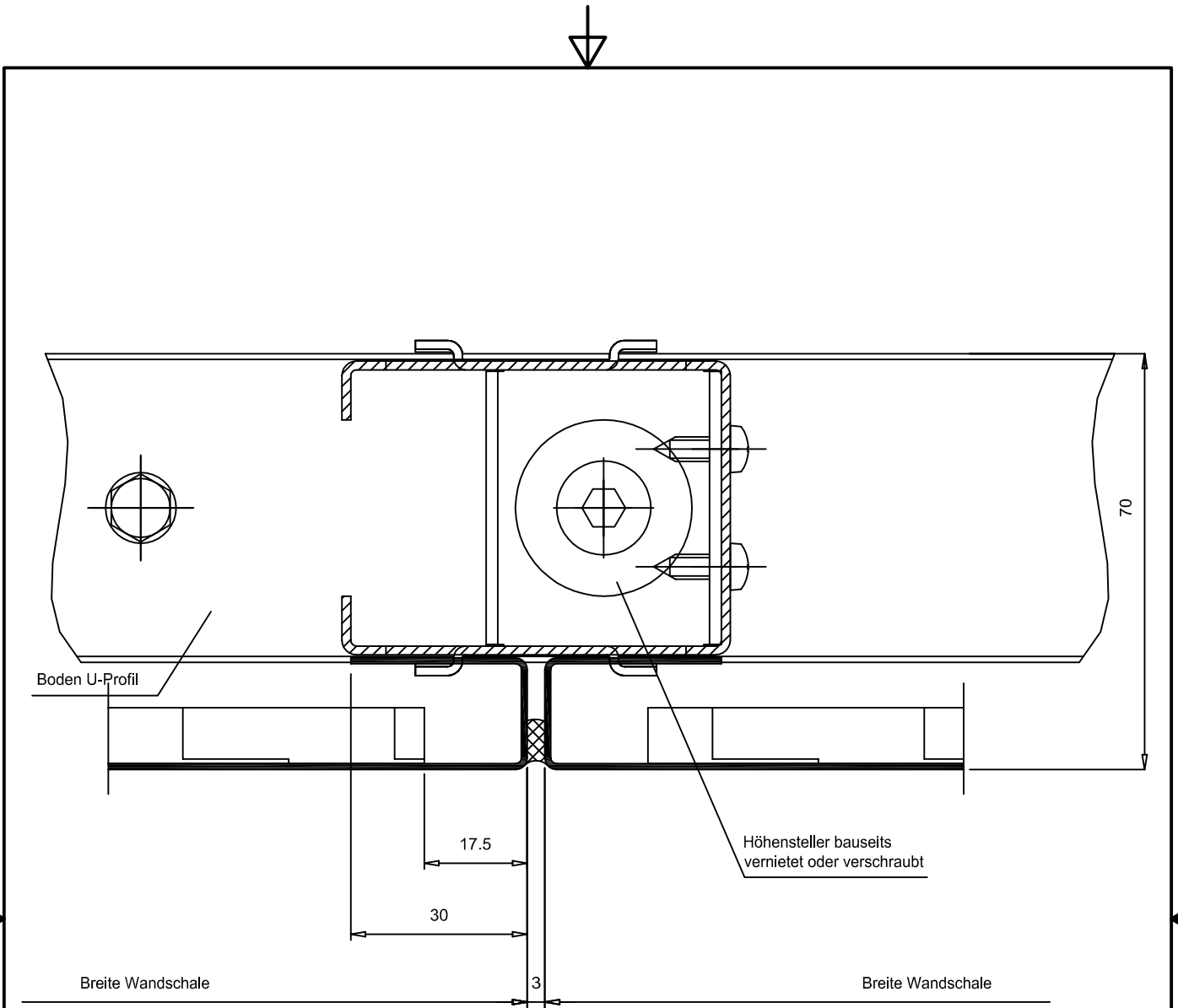

Alle Toleranzen nach DIN ISO 2768 mittel		Material		
This drawing is our literary property and may neither copied nor to be exposed approachable to third persons without our agreement; according to German Copyright Act				
		Datum	Name	Description / Bezeichnung: D 001A Trennwand zweifach Verglasung
		Gezeichnet	16.07.2014 jk	
		Kontrolliert		
		Norm		
		Projekt Nr. PRO_XXX		Z-Nr: VRS_P90_12_0002
				1
				A4
Status	Änderungen	Datum	Name	



Alle Toleranzen nach DIN ISO 2768 mittel				Material			
This drawing is our literary property and may neither copied nor to be exposed approachable to third persons without our agreement; according to German Copyright Act							
				Datum	Name	Description / Bezeichnung: D 001 B Trennwand halb	
				Gezeichnet	16.07.2014		jk
				Kontrolliert			
				Norm			
				Projekt Nr. PRO_XXX		Z-Nr: VRS_P90_12_0003	
						1	
						A4	
Status	Änderungen	Datum	Name				

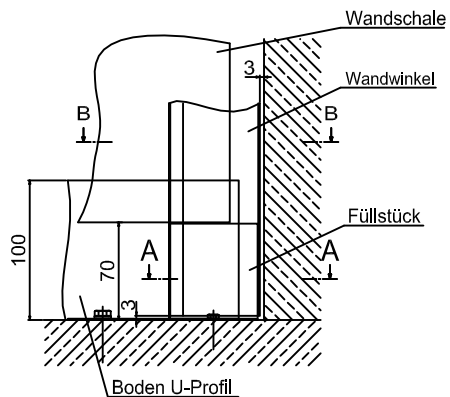

### Schnitt A-A

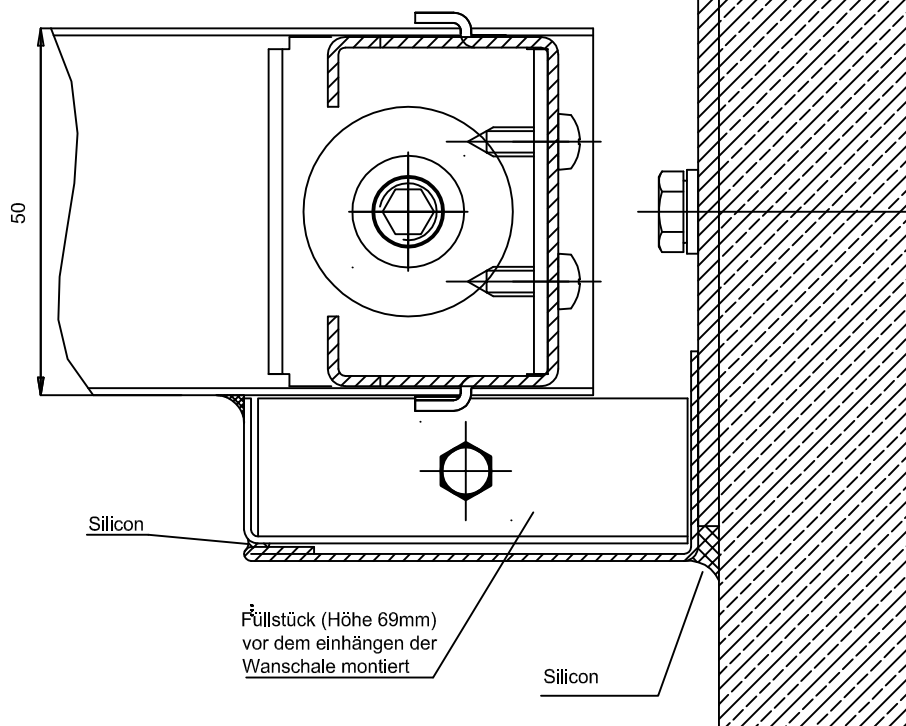

Alle Toleranzen nach DIN ISO 2768 mittel			Material		
<small>This drawing is our literary property and may neither copied nor to be exposed approachable to third persons without our agreement; according to German Copyright Act</small>					
			Datum	Name	Description / Bezeichnung:  D 002 Wandanschluss Trennwand halb
			Gezeichnet	23.07.2014 jk	
			Kontrolliert		
			Norm		
			Projekt Nr.		Z-Nr: VRS_P90_12_0004
			PRO_XXX		
Status	Änderungen	Datum	Name		<div style="text-align: right; font-size: 24pt; font-weight: bold;">1</div> <div style="text-align: right;">A4</div>



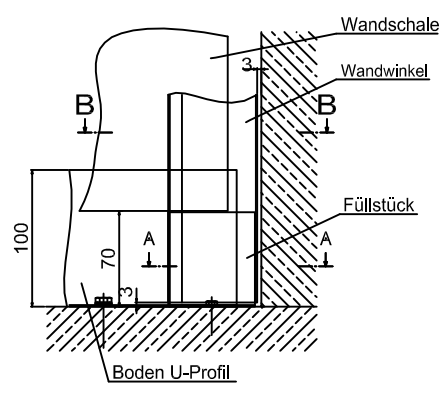

### Schnitt B-B

nach dem Einhängen der Wandschale wird der Wandwinkel auf den Blechstreifen geklebt

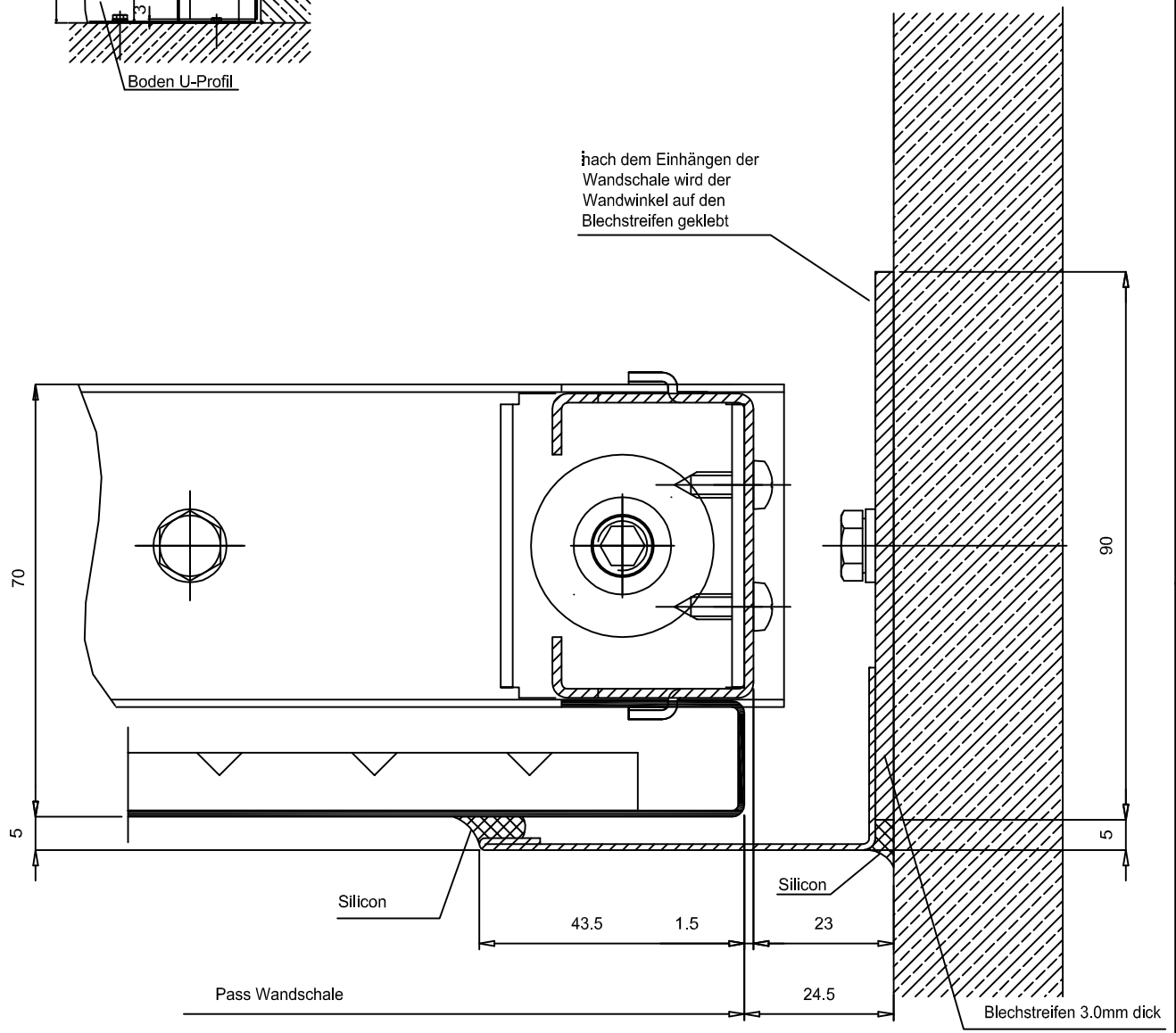

Alle Toleranzen nach DIN ISO 2768 mittel		Material		
<small>This drawing is our literary property and may neither copied nor to be exposed approachable to third persons without our agreement; according to German Copyright Act</small>				
		Datum	Name	Description / Bezeichnung:  D 002 A Wandanschluss Trennwand halb
		Gezeichnet	23.07.2014 jk	
		Kontrolliert		
		Norm		
		Projekt Nr.		Z-Nr: VRS_P90_12_0005
		PRO_XXX		
Status	Änderungen	Datum	Name	1
				A4

# Schnitt A-A

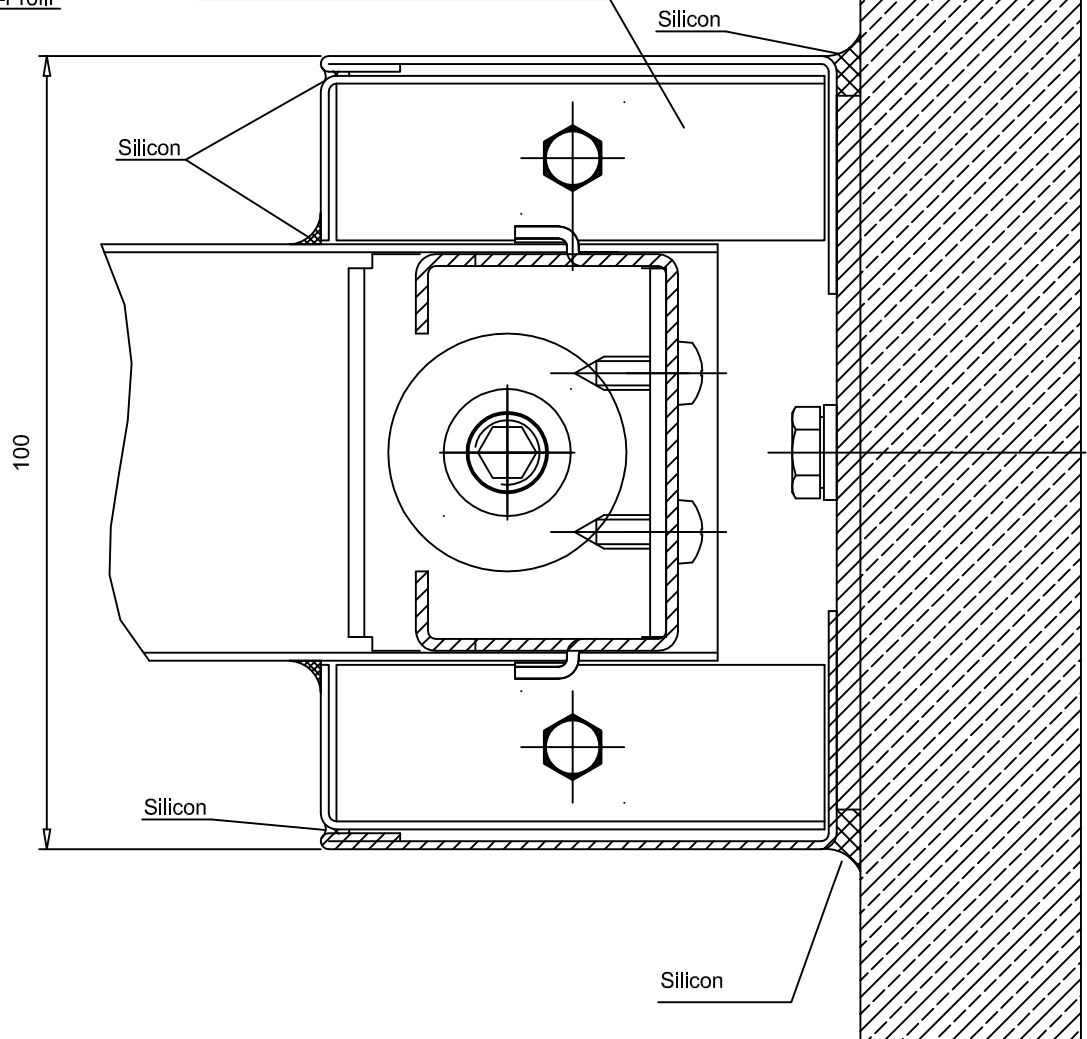
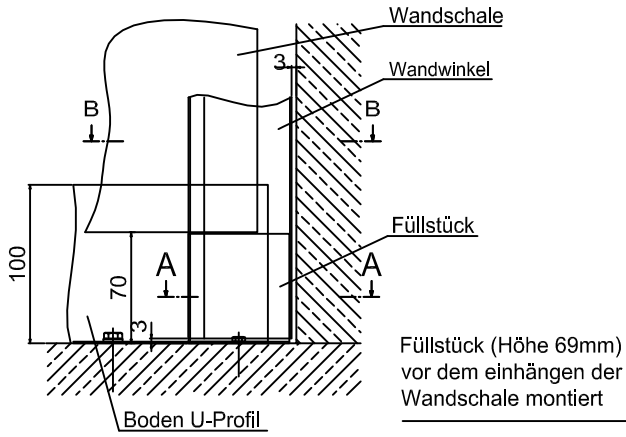

Alle Toleranzen nach DIN ISO 2768 mittel		Material		
This drawing is our literary property and may neither copied nor to be exposed approachable to third persons without our agreement; according to German Copyright Act				
		Datum	Name	Description / Bezeichnung: D 002 B Wandanschluss Trennwand voll
		Gezeichnet	23.07.2014 jk	
		Kontrolliert		
		Norm		
		Projekt Nr. PRO_XXX		Z-Nr: VRS_P90_12_0006
Status	Änderungen	Datum	Name	1 A4

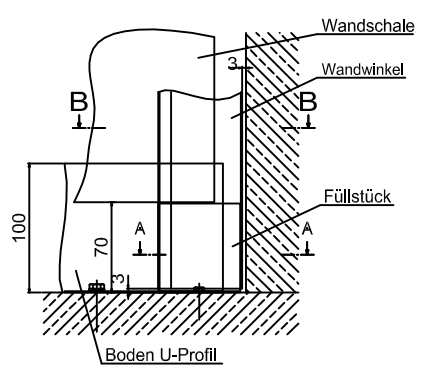

### Schnitt B-B

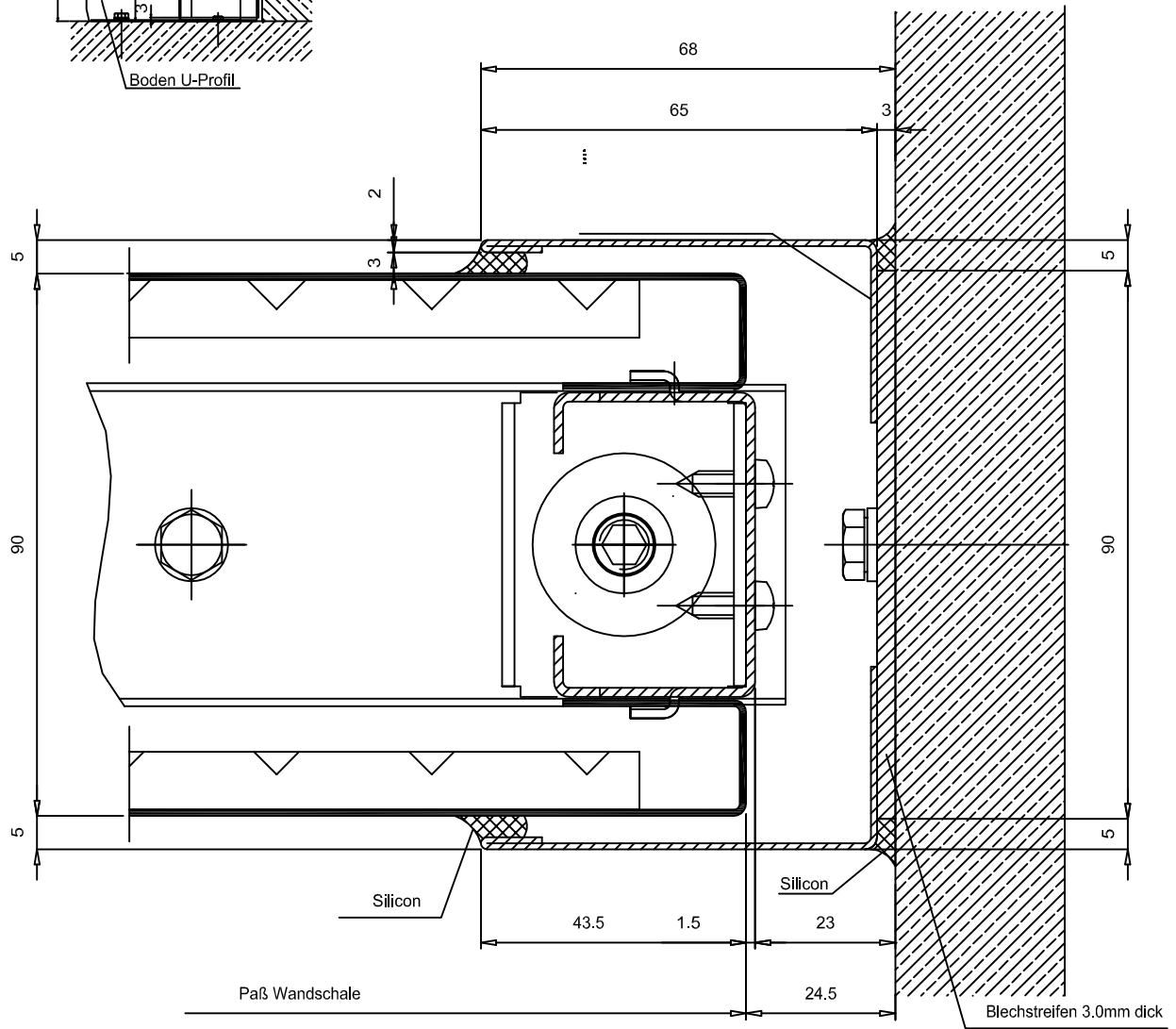



Alle Toleranzen nach DIN ISO 2768 mittel		Material		
This drawing is our literary property and may neither copied nor to be exposed approachable to third persons without our agreement; according to German Copyright Act				
		Datum	Name	Description / Bezeichnung: D 002 C Wandanschluss Trennwand voll
		Gezeichnet	23.07.2014 jk	
		Kontrolliert		
		Norm		
		Projekt Nr. PRO_XXX		Z-Nr: VRS_P90_12_0007
Status	Änderungen	Datum	Name	1 A4

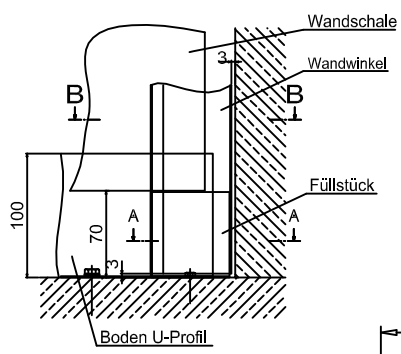

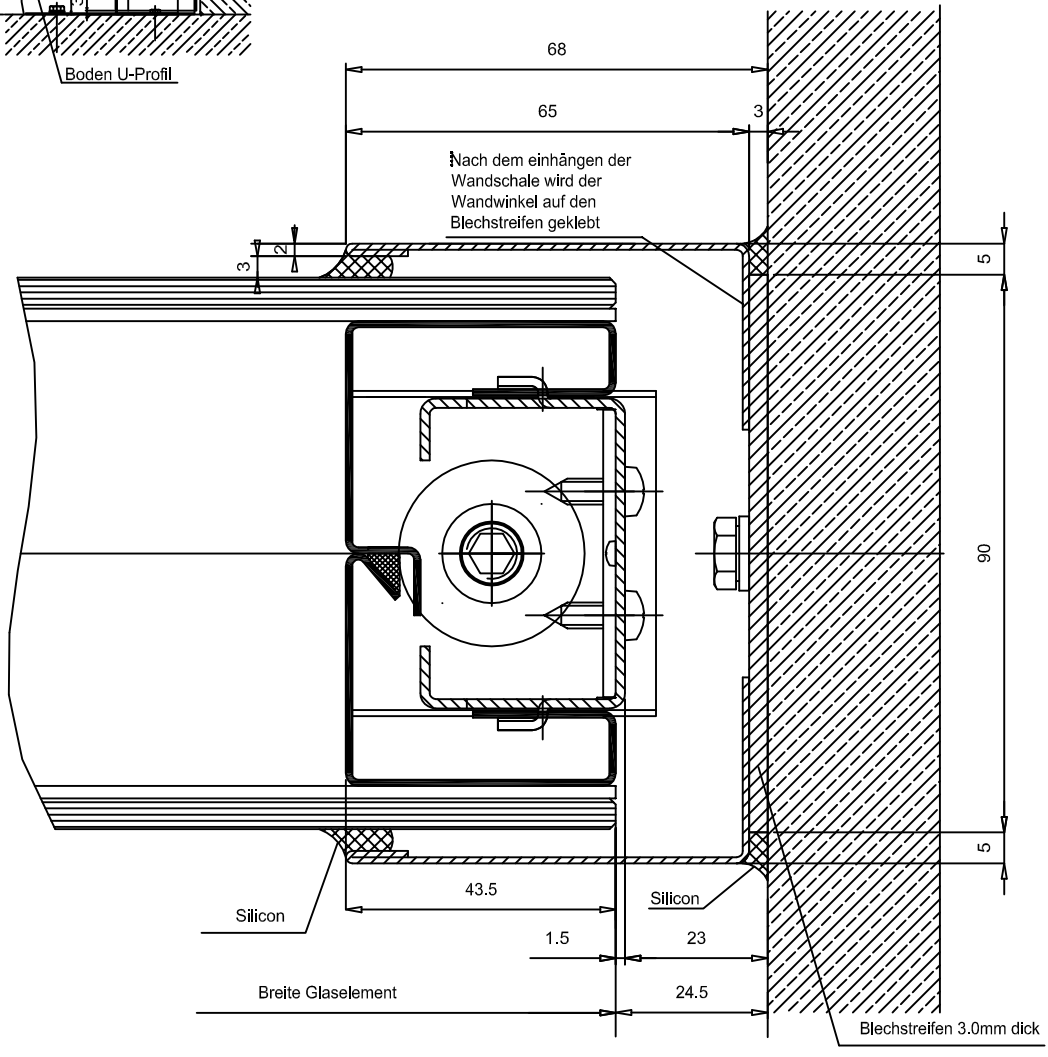

### Schnitt B-B



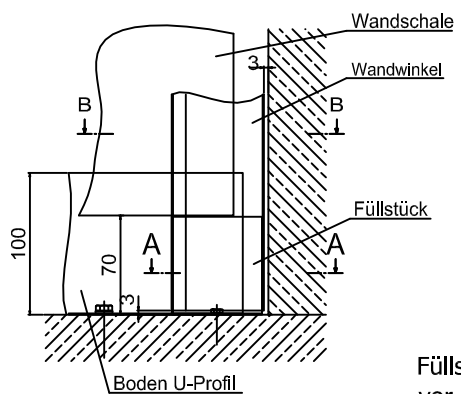

Alle Toleranzen nach DIN ISO 2768 mittel		Material		
This drawing is our literary property and may neither copied nor to be exposed approachable to third persons without our agreement; according to German Copyright Act				
		Datum	Name	Description / Bezeichnung: D 002 D Wandanschluss Glaselement
		Gezeichnet	23.07.2014 jk	
		Kontrolliert		
		Norm		
		Projekt Nr. PRO_XXX		Z-Nr: VRS_P90_12_0008
Status	Änderungen	Datum	Name	<div style="font-size: 2em; font-weight: bold;">1</div> <div>A4</div>



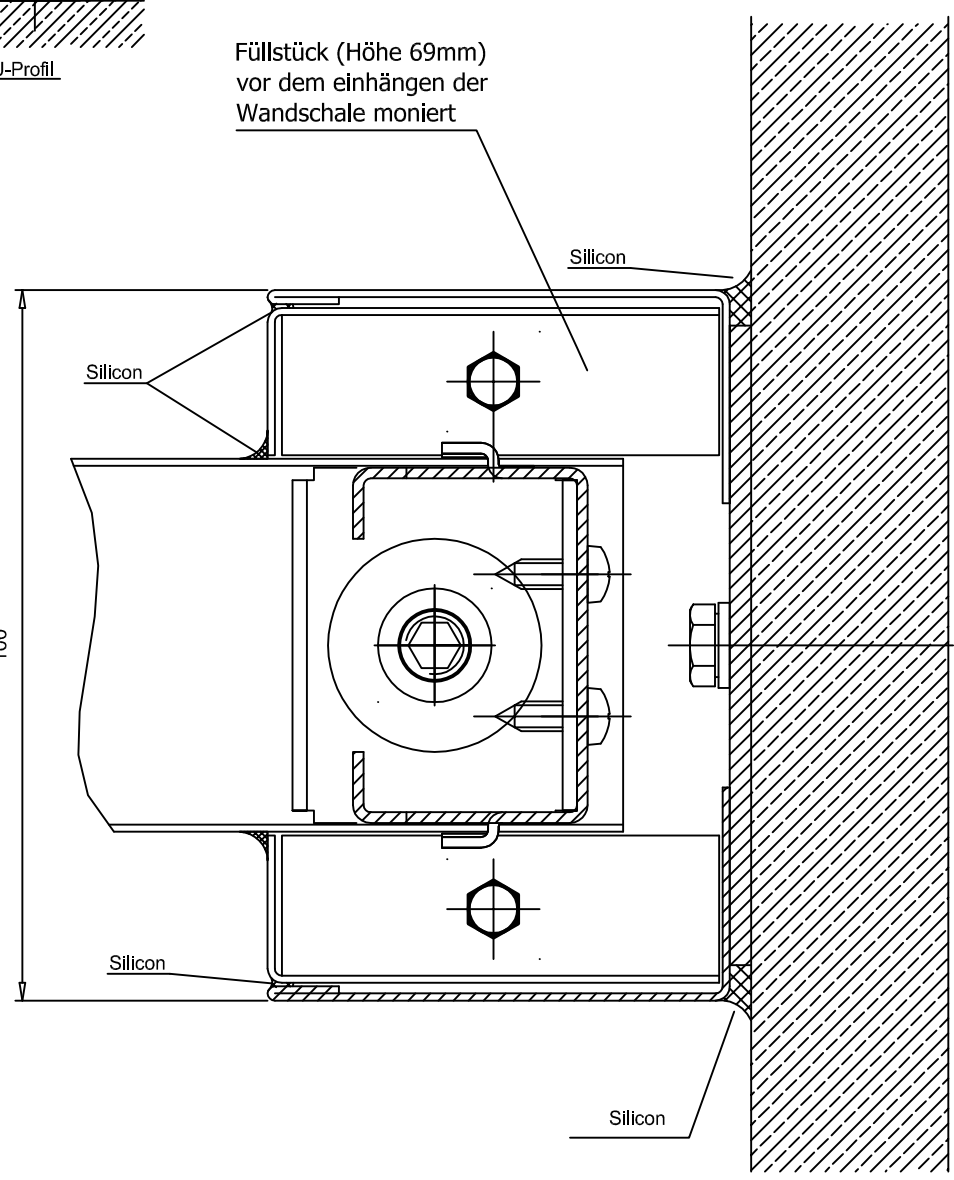

# Schnitt A-A

Füllstück (Höhe 69mm)  
vor dem einhängen der  
Wandschale montiert

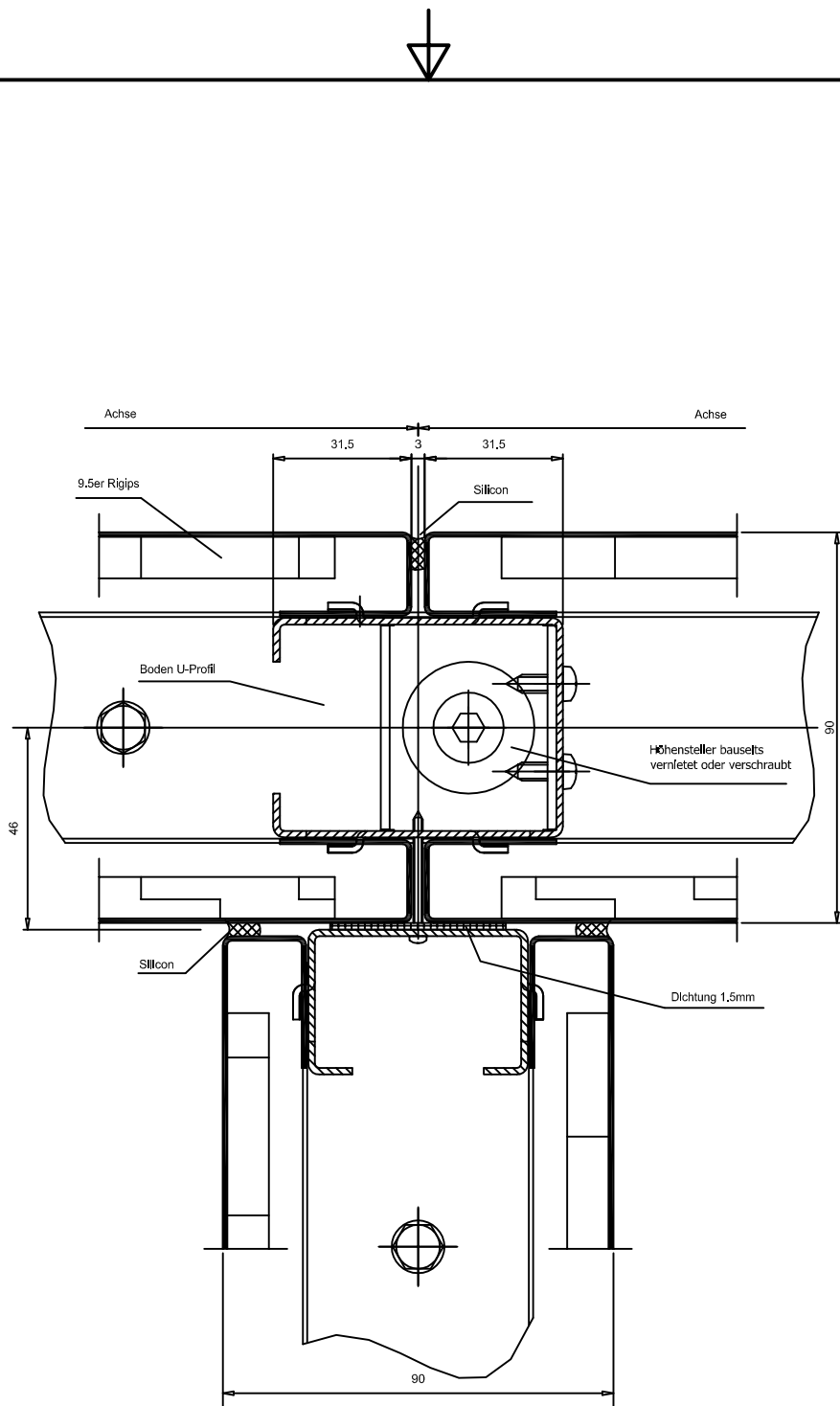

Alle Toleranzen nach DIN ISO 2768 mittel		Material		
<small>This drawing is our literary property and may neither copied nor to be exposed approachable to third persons without our agreement; according to German Copyright Act</small>				
		Datum	Name	Description / Bezeichnung:  D 002 E Wandanschluss Glaselement
		Gezeichnet	23.07.2014 jk	
		Kontrolliert		
		Norm		
		Projekt Nr.		Z-Nr: VRS_P90_12_0009
		PRO_XXX		
Status	Änderungen	Datum	Name	<div style="text-align: right; font-size: 24pt; font-weight: bold;">1</div> <div style="text-align: right;">A4</div>



Alle Toleranzen nach DIN ISO 2768 mittel		Material		
<small>This drawing is our literary property and may neither copied nor to be exposed approachable to third persons without our agreement; according to German Copyright Act</small>				
		Datum	Name	Description / Bezeichnung: D 003 T-Anschluss Voll/Voll/Voll
		Gezeichnet	23.07.2014 jk	
		Kontrolliert		
		Norm		
		Projekt Nr.		Z-Nr: VRS_P90_12_0010
		PRO_XXX		
Status	Änderungen	Datum	Name	1 A4

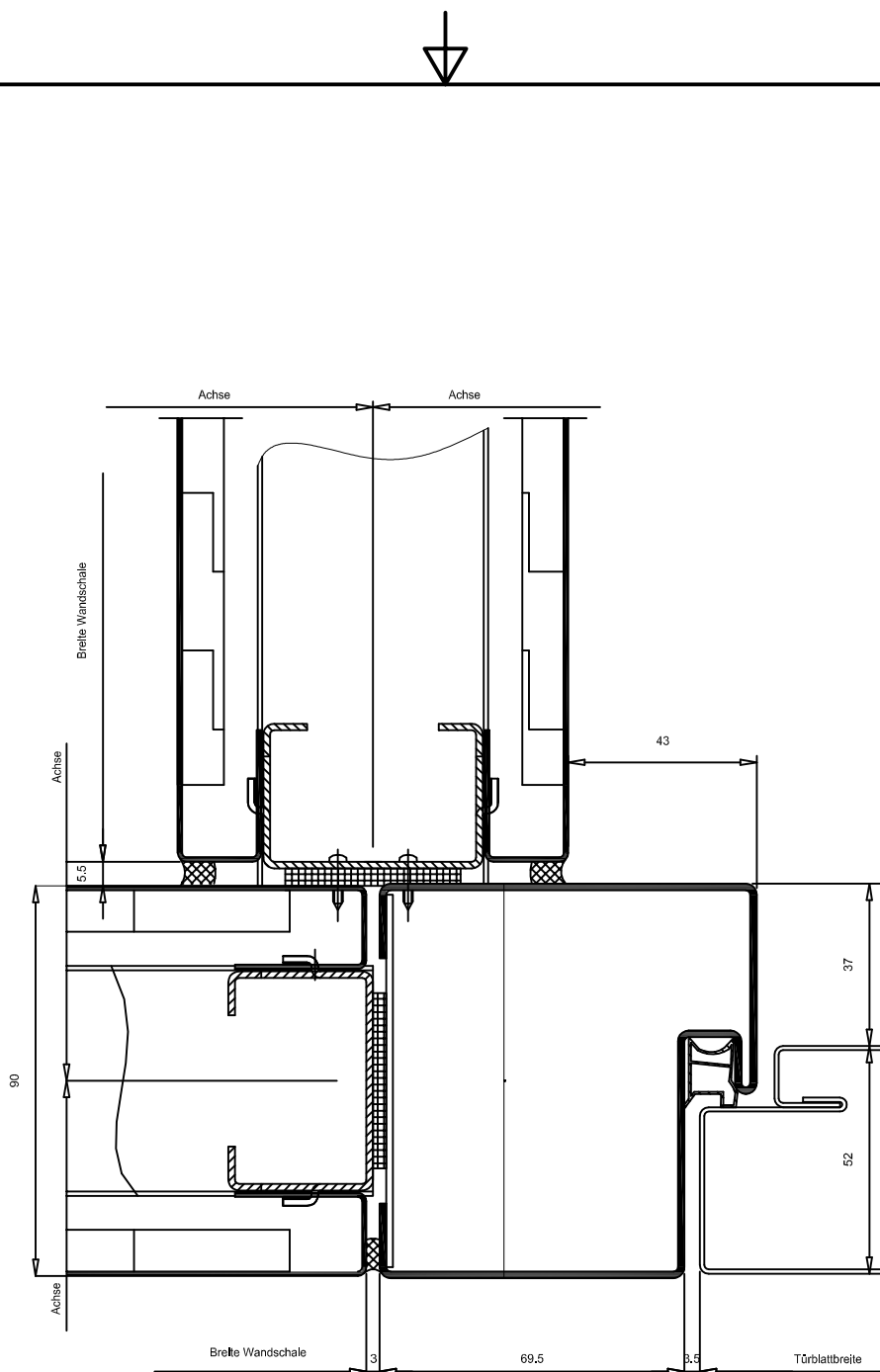

Alle Toleranzen nach DIN ISO 2768 mittel				Material		
This drawing is our literary property and may neither copied nor to be exposed approachable to third persons without our agreement; according to German Copyright Act						
				Datum	Name	Description / Bezeichnung: D 003 A T-Anschluss Trennwand Voll/Voll/Tür
				Gezeichnet	23.07.2014 jk	
				Kontrolliert		
				Norm		
				Projekt Nr. PRO_XXX		Z-Nr: VRS_P90_12_0011
						1
						A4
Status	Änderungen	Datum	Name			

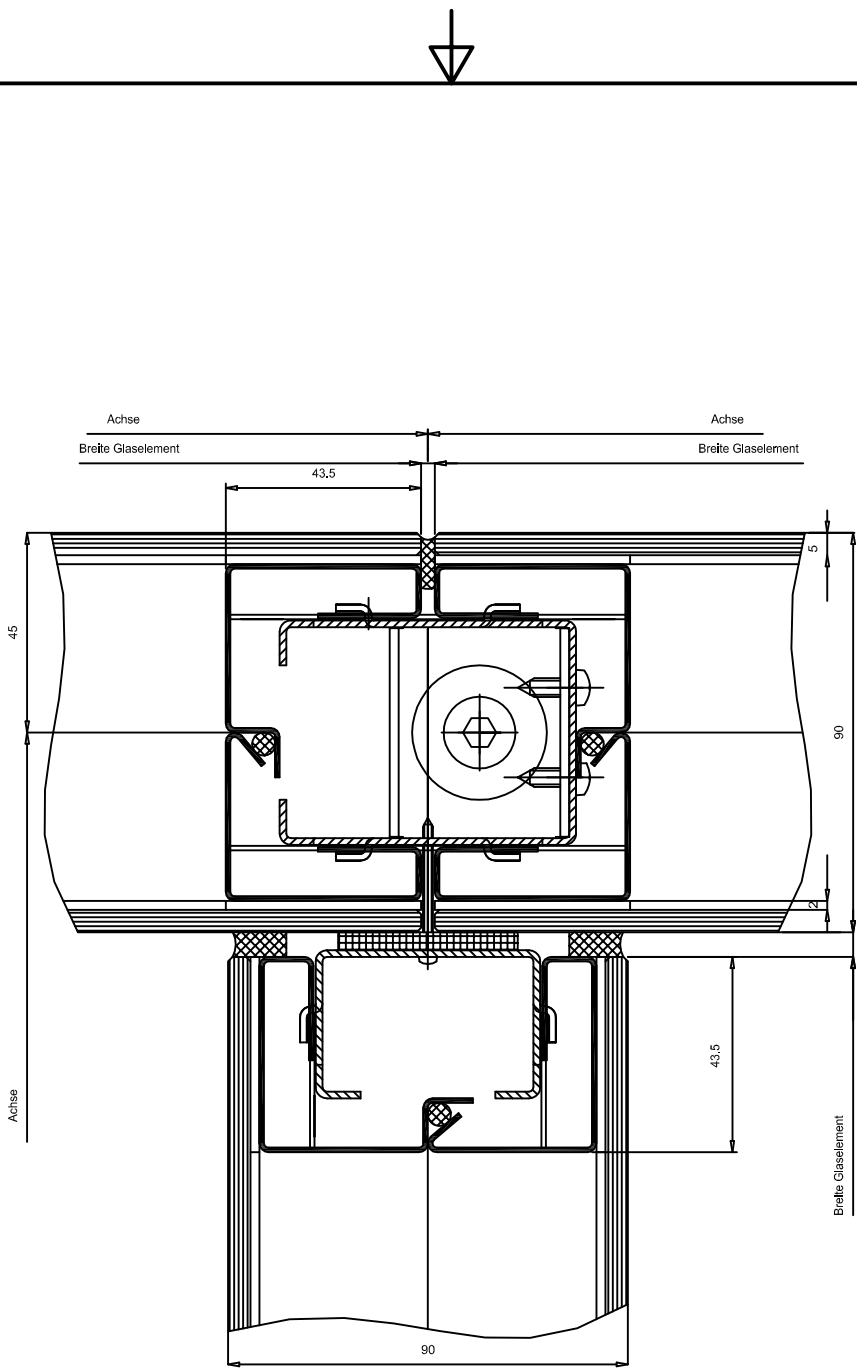

Alle Toleranzen nach DIN ISO 2768 mittel				Material		
This drawing is our literary property and may neither copied nor to be exposed approachable to third persons without our agreement; according to German Copyright Act						
				Datum	Name	Description / Bezeichnung: D 003 B T-Anschluss Trennwand Glas/Glas/Glas
				Gezeichnet	24.07.2014 jk	
				Kontrolliert		
				Norm		
				Projekt Nr. PRO_XXX		Z-Nr: VRS_P90_12_0012
						1
						A4
Status	Änderungen	Datum	Name			

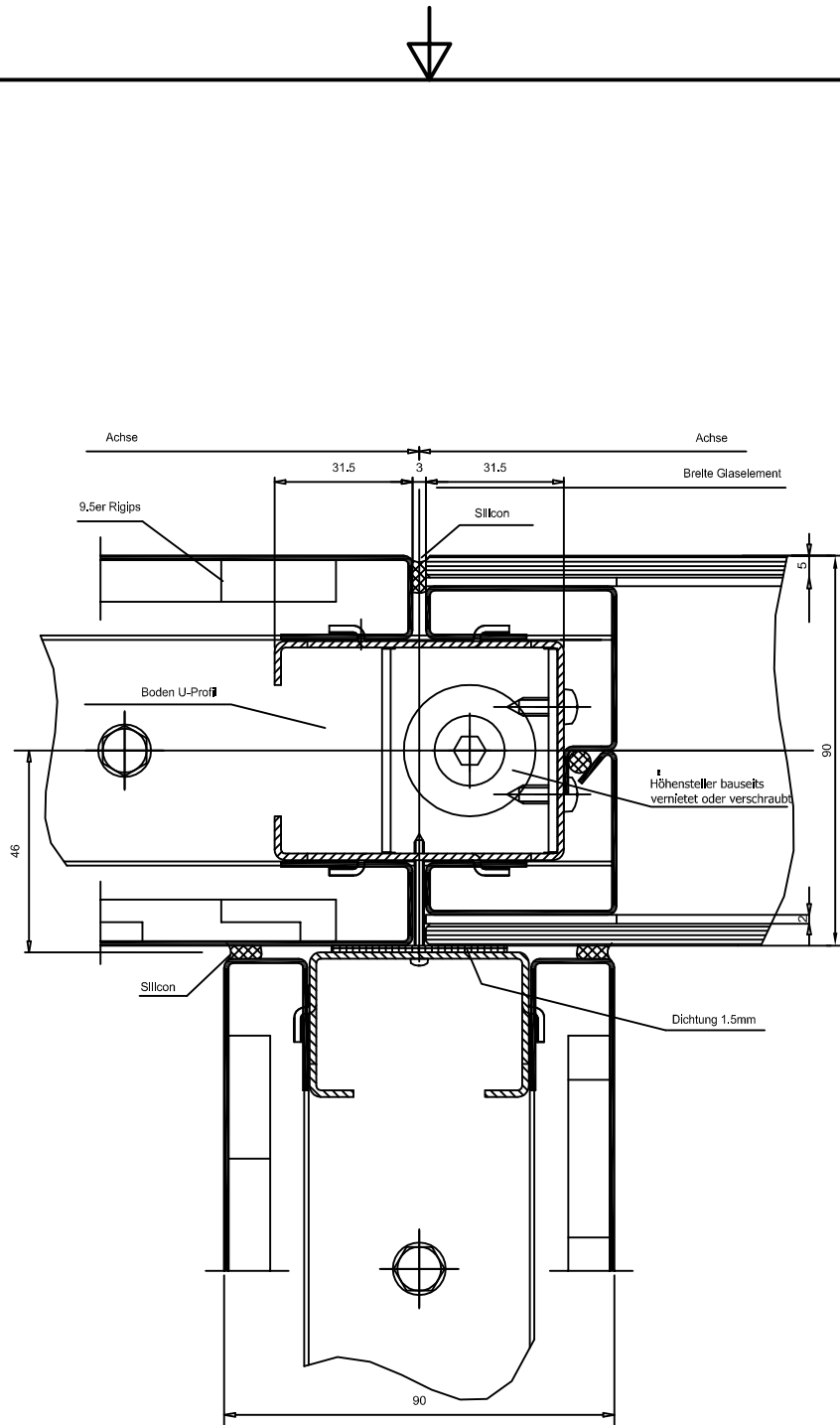

Alle Toleranzen nach DIN ISO 2768 mittel		Material		
This drawing is our literary property and may neither copied nor to be exposed approachable to third persons without our agreement; according to German Copyright Act				
		Datum	Name	Description / Bezeichnung: D 003 C T-Anschluss Trennwand Voll/Glas/Voll
		Gezeichnet	24.07.2014 jk	
		Kontrolliert		
		Norm		
		Projekt Nr. PRO_XXX		Z-Nr: VRS_P90_12_0013
Status	Änderungen	Datum	Name	1 A4

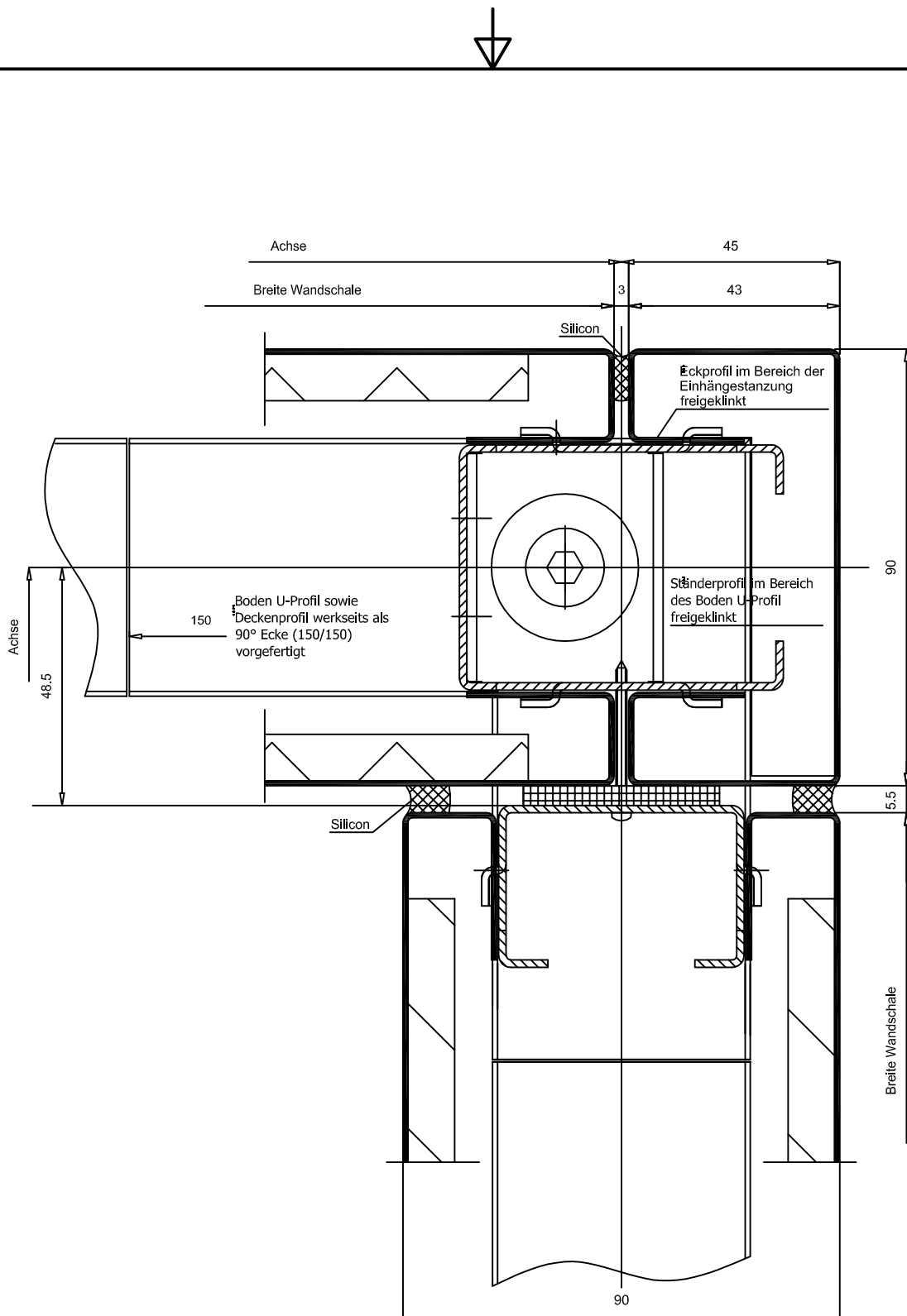

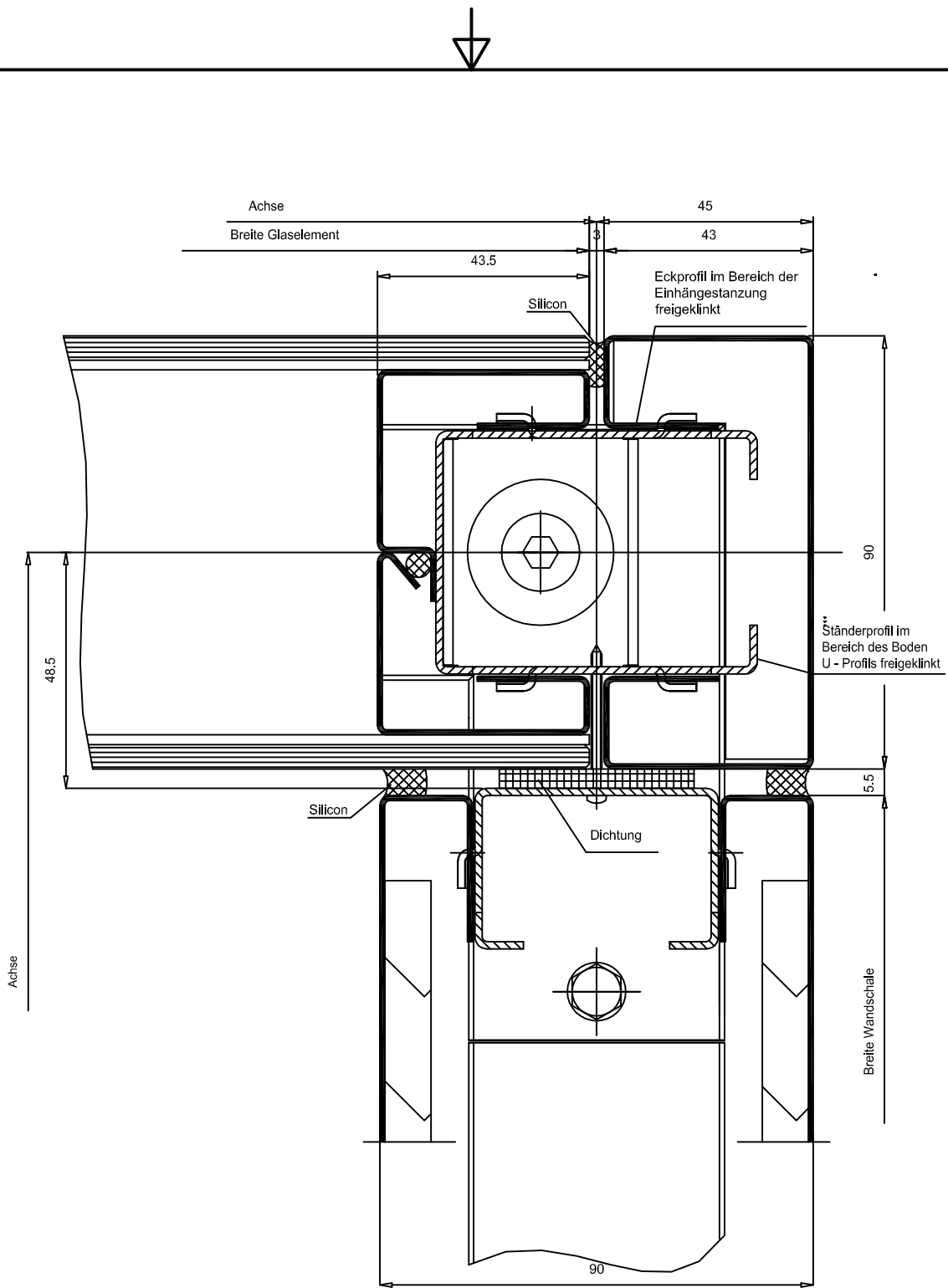

Alle Toleranzen nach DIN ISO 2768 mittel		Material		
This drawing is our literary property and may neither copied nor to be exposed approachable to third persons without our agreement; according to German Copyright Act				
		Datum	Name	Description / Bezeichnung: D 004 Eckausbildung Trennwand Voll/Voll
		Gezeichnet	24.07.2014 jk	
		Kontrolliert		
		Norm		
		Projekt Nr. PRO_XXX		Z-Nr: VRS_P90_12_0014
Status	Änderungen	Datum	Name	1 A4



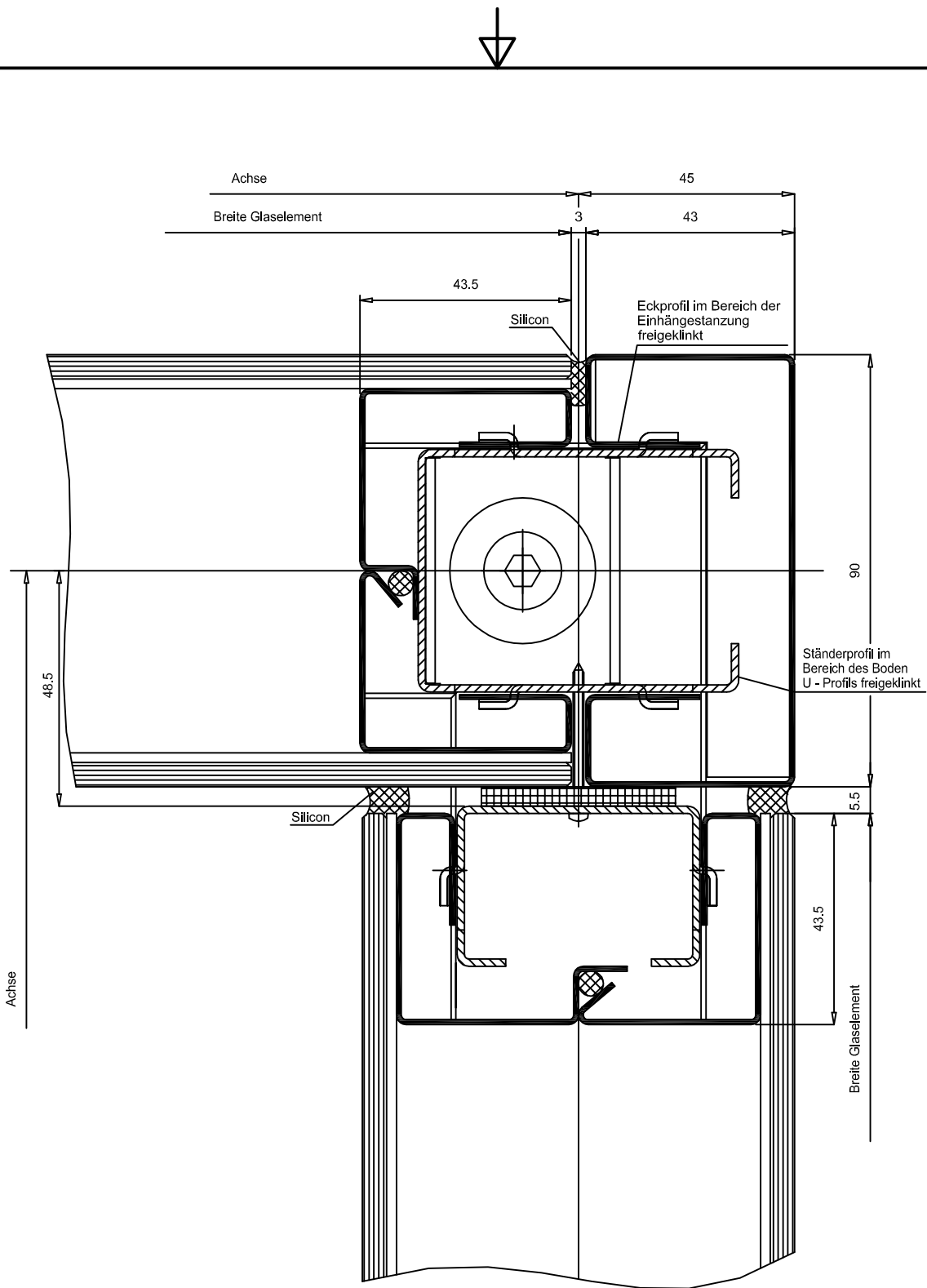

Alle Toleranzen nach DIN ISO 2768 mittel		Material		
This drawing is our literary property and may neither copied nor to be exposed approachable to third persons without our agreement; according to German Copyright Act				
		Datum	Name	Description / Bezeichnung: D 004 A Eckausbildung Trennwand Voll/Verglast
		Gezeichnet	24.07.2014 jk	
		Kontrolliert		
		Norm		
		Projekt Nr. PRO_XXX		Z-Nr: VRS_P90_12_0015
Status	Änderungen	Datum	Name	1 A4





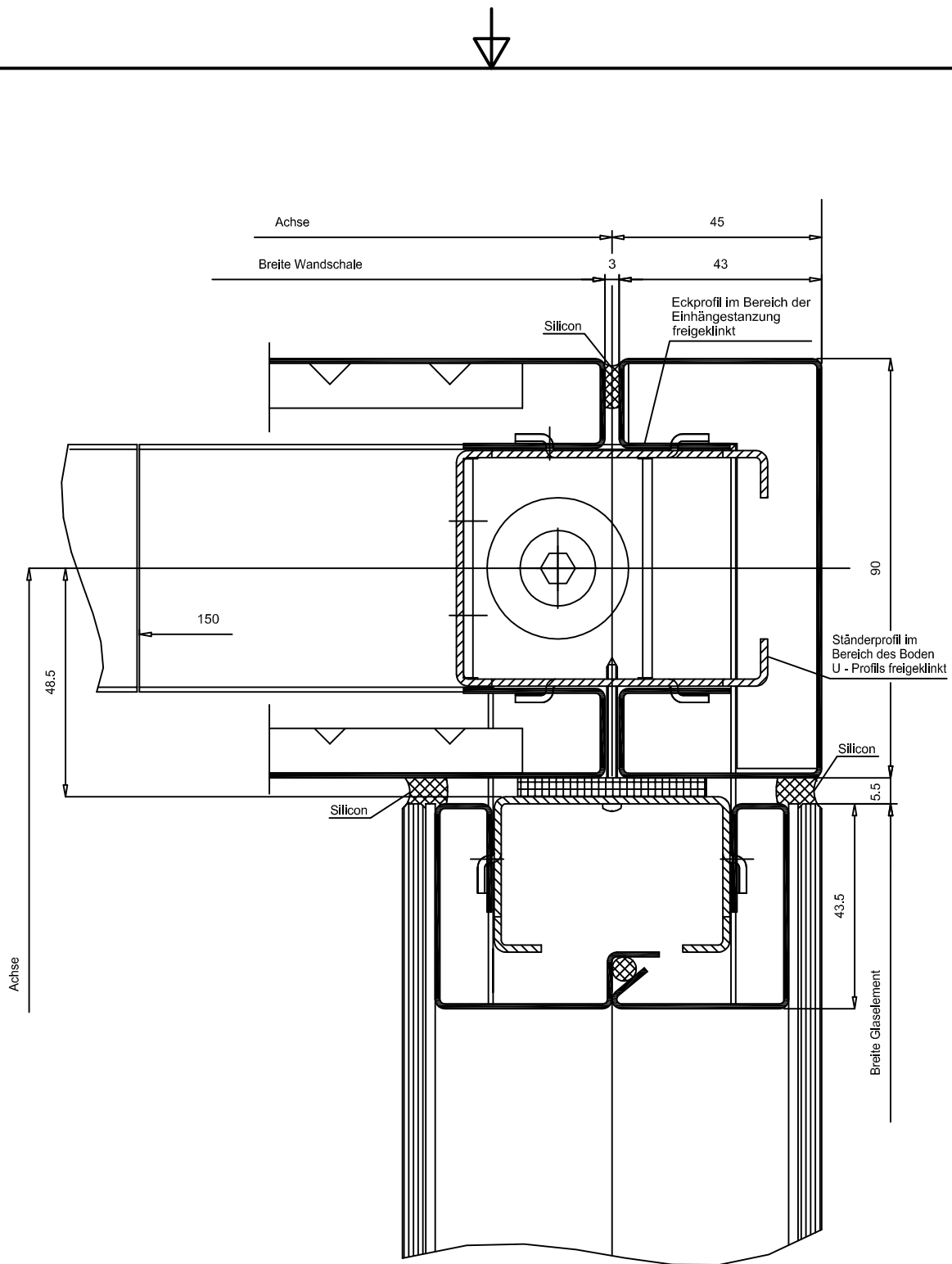

Alle Toleranzen nach DIN ISO 2768 mittel		Material		
This drawing is our literary property and may neither copied nor to be exposed approachable to third persons without our agreement; according to German Copyright Act				
		Datum	Name	Description / Bezeichnung: D 004 B Eckausbildung Trennwand Verglast/Verglast
		Gezeichnet	24.07.2014 jk	
		Kontrolliert		
		Norm		
		Projekt Nr. PRO_XXX		Z-Nr: VRS_P90_12_0016
Status	Änderungen	Datum	Name	1 A4

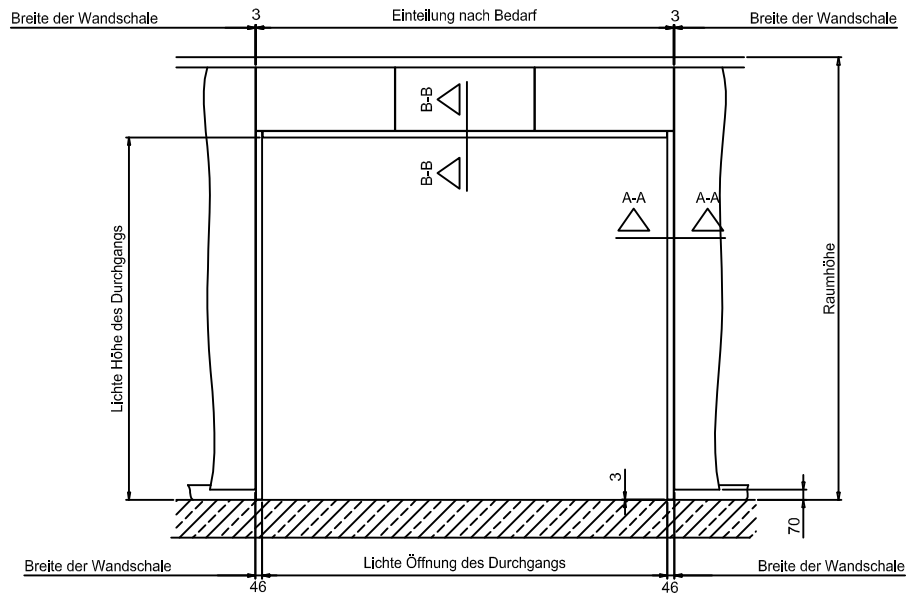
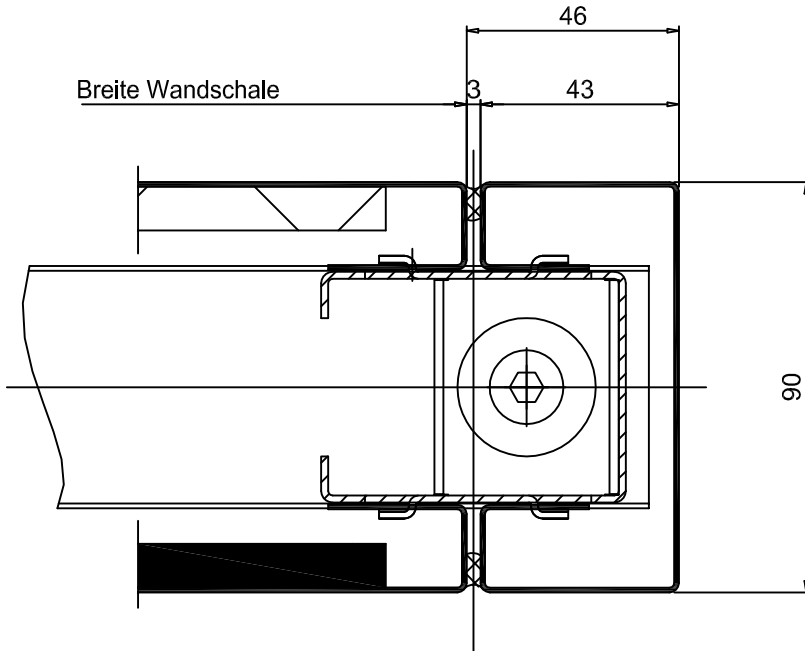

Alle Toleranzen nach DIN ISO 2768 mittel		Material		
This drawing is our literary property and may neither copied nor to be exposed approachable to third persons without our agreement; according to German Copyright Act				
		Datum	Name	Description / Bezeichnung: D 004 C Eckausbildung Trennwand Verglast/Voll
		Gezeichnet	24.07.2014 jk	
		Kontrolliert		
		Norm		
		Projekt Nr. PRO_XXX		Z-Nr: VRS_P90_12_0017
				1
				A4
Status	Änderungen	Datum	Name	

# Schnitt A-A



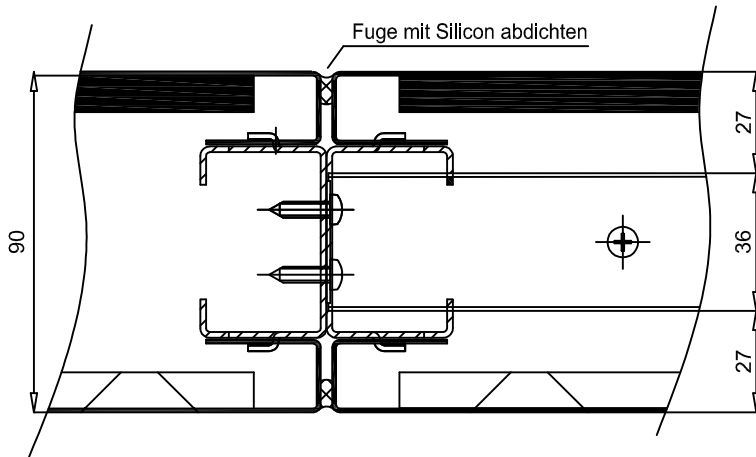

Alle Toleranzen nach DIN ISO 2768 mittel				Material			
This drawing is our literary property and may neither copied nor to be exposed approachable to third persons without our agreement; according to German Copyright Act							
				Datum	Name	Description / Bezeichnung: D 010 Durchgangszarge	
				Gezeichnet	25.07.2014		jk
				Kontrolliert			
				Norm			
				Projekt Nr. PRO_XXX		Z-Nr: VRS_P90_12_0018	
						1	
						A4	
Status	Änderungen	Datum	Name				

### Schnitt A-A

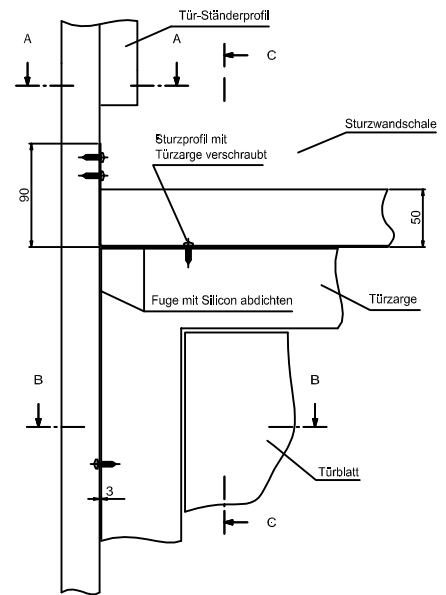
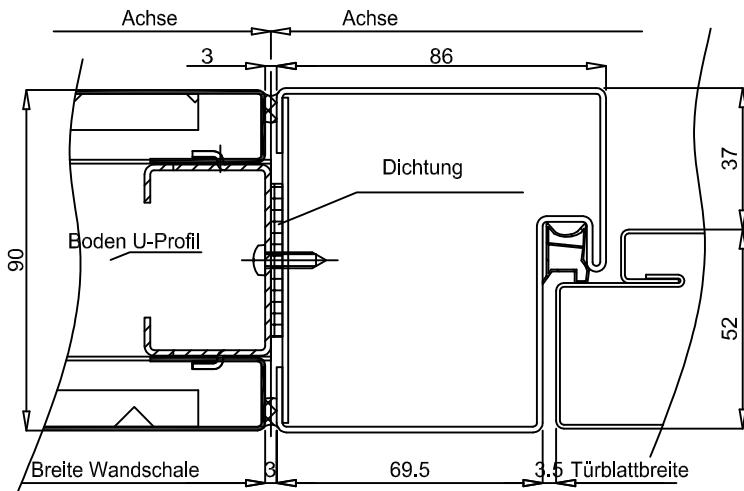

### Schnitt B-B



Alle Toleranzen nach DIN ISO 2768 mittel		Material		
This drawing is our literary property and may neither copied nor to be exposed approachable to third persons without our agreement; according to German Copyright Act				
		Datum	Name	Description / Bezeichnung: D 012 Türanschluss an Vollwand
		Gezeichnet	25.07.2014 jk	
		Kontrolliert		
		Norm		
		Projekt Nr. PRO_XXX		Z-Nr: VRS_P90_12_0019
Status	Änderungen	Datum	Name	1 A4

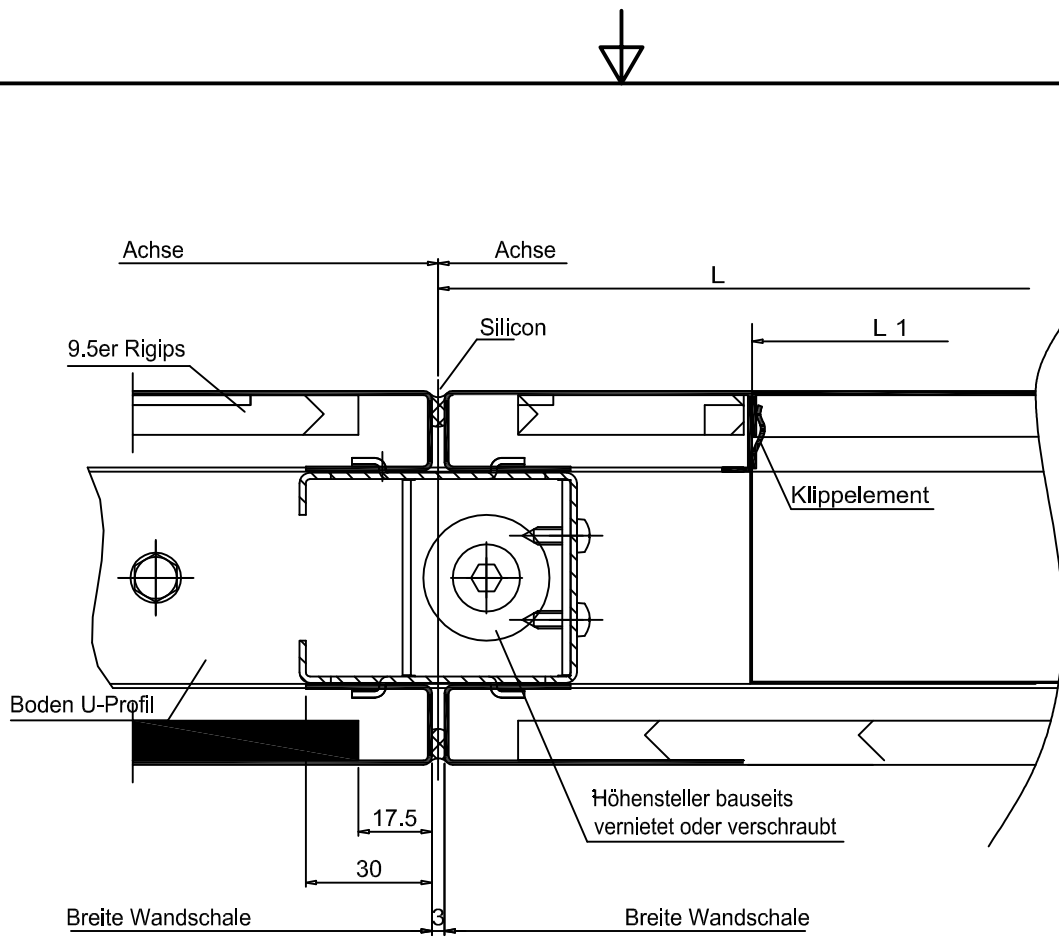

Ansicht

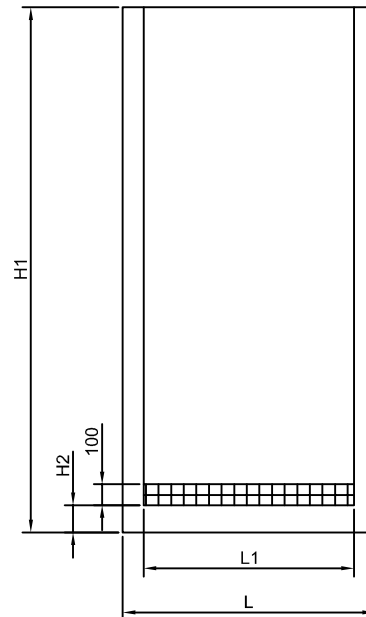

Alle Toleranzen nach DIN ISO 2768 mittel		Material		
This drawing is our literary property and may neither copied nor to be exposed approachable to third persons without our agreement; according to German Copyright Act				
		Datum	Name	Description / Bezeichnung: D 013 Rücklaufschacht integriert
		Gezeichnet	25.07.2014 jk	
		Kontrolliert		
		Norm		
		Projekt Nr. PRO_XXX		Z-Nr: VRS_P90_12_0020
Status	Änderungen	Datum	Name	1 A4

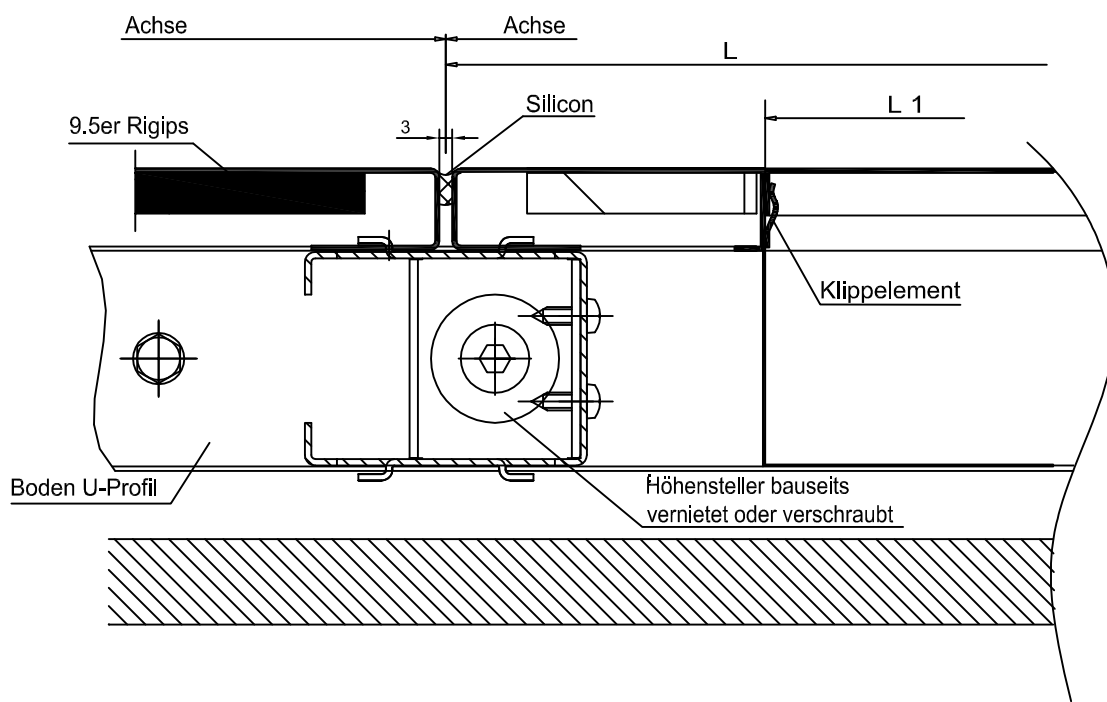

Ansicht

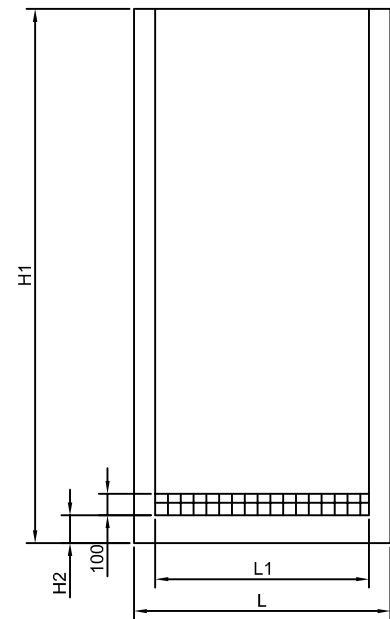

Alle Toleranzen nach DIN ISO 2768 mittel				Material		
This drawing is our literary property and may neither copied nor to be exposed approachable to third persons without our agreement; according to German Copyright Act						
				Datum	Name	Description / Bezeichnung: D 013 A Rückluftschtacht integriert mit Wandverkleidung
				Gezeichnet	25.07.2014 jk	
				Kontrolliert		
				Norm		
				Projekt Nr. PRO_XXX		Z-Nr: VRS_P90_12_0021
Status	Änderungen	Datum	Name			1 A4

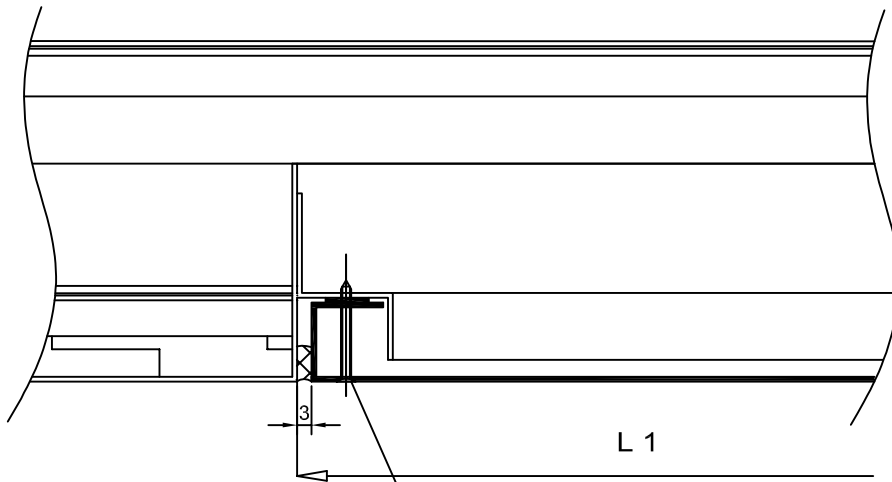

4 Befestigungsschrauben

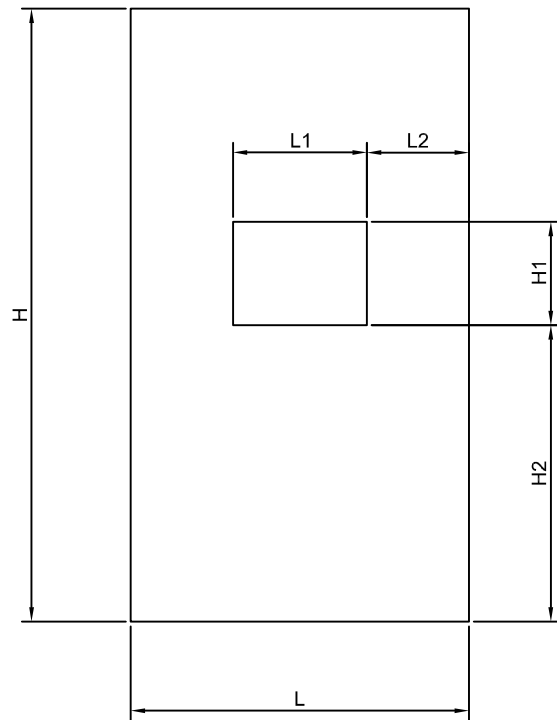

Alle Toleranzen nach DIN ISO 2768 mittel				Material		
This drawing is our literary property and may neither copied nor to be exposed approachable to third persons without our agreement; according to German Copyright Act						
				Datum	Name	Description / Bezeichnung: D 013 B Installation Trennwand halb
				Gezeichnet	25.07.2014 jk	
				Kontrolliert		
				Norm		
				Projekt Nr. PRO_XXX		Z-Nr: VRS_P90_12_0022
						1
						A4
Status	Änderungen	Datum	Name			

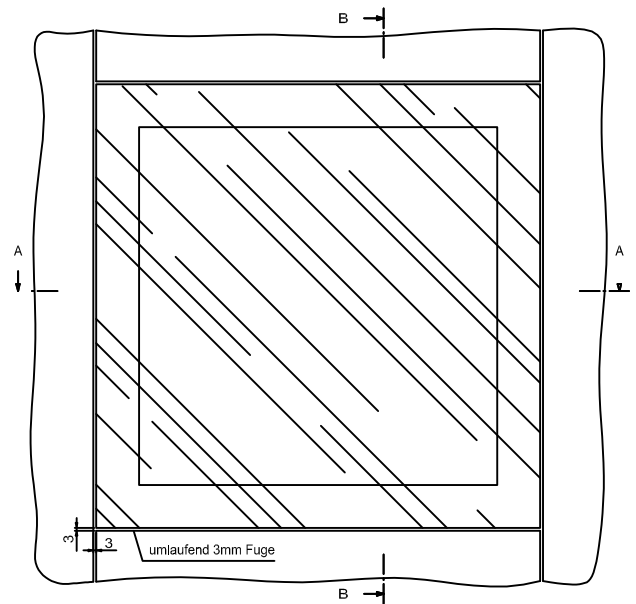

Schnitt A-A

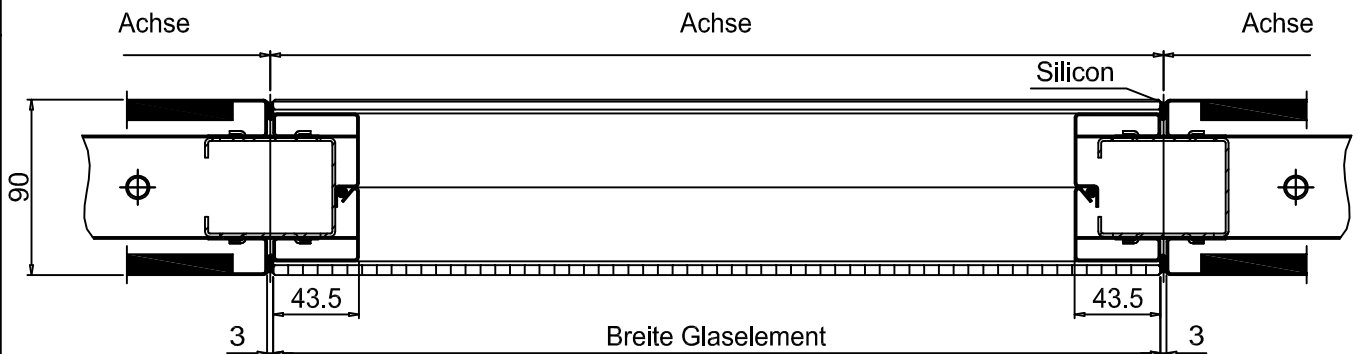

Alle Toleranzen nach DIN ISO 2768 mittel		Material		
This drawing is our literary property and may neither copied nor to be exposed approachable to third persons without our agreement; according to German Copyright Act				
		Datum	Name	Description / Bezeichnung: D 014 A Trennwandverglasung
		Gezeichnet	25.07.2014 jk	
		Kontrolliert		
		Norm		
		Projekt Nr. PRO_XXX		Z-Nr: VRS_P90_12_0023
				1
				A4
Status	Änderungen	Datum	Name	





# TECHNICAL DATA SHEET

## WALL TYPE P98

### Wall system with suspended steel sheet lagging

Surface of beam / extrusion	Aluminium, blank
Surface of panels	Powder-coated, gloss level 30, backside primed 5 µm
Panels	Steel sheet panel 1 mm
Standard grid	1200 mm
Standard color	RAL 9010
Filling	none or on request
Wall height	2500 mm to 4500 mm, depends on grid size
Wall thickness	98 mm

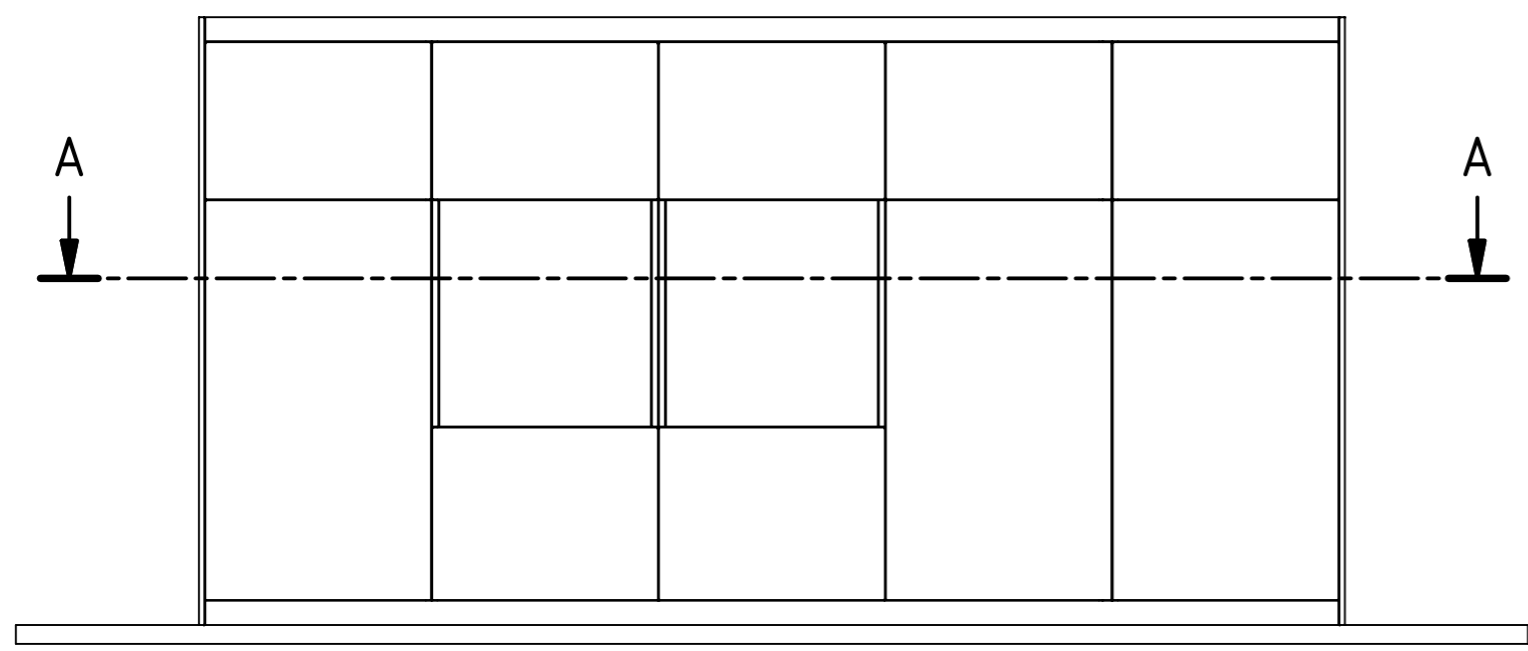

A-A

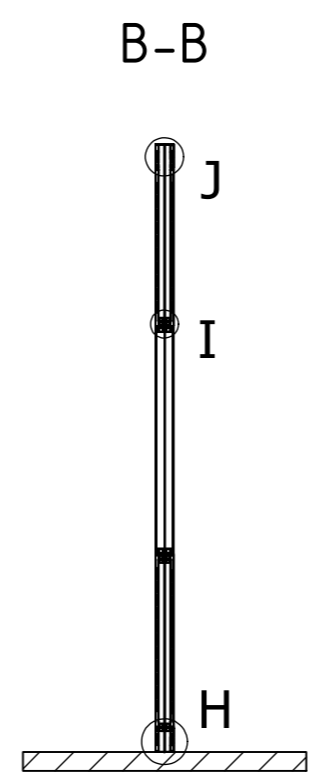

B-B

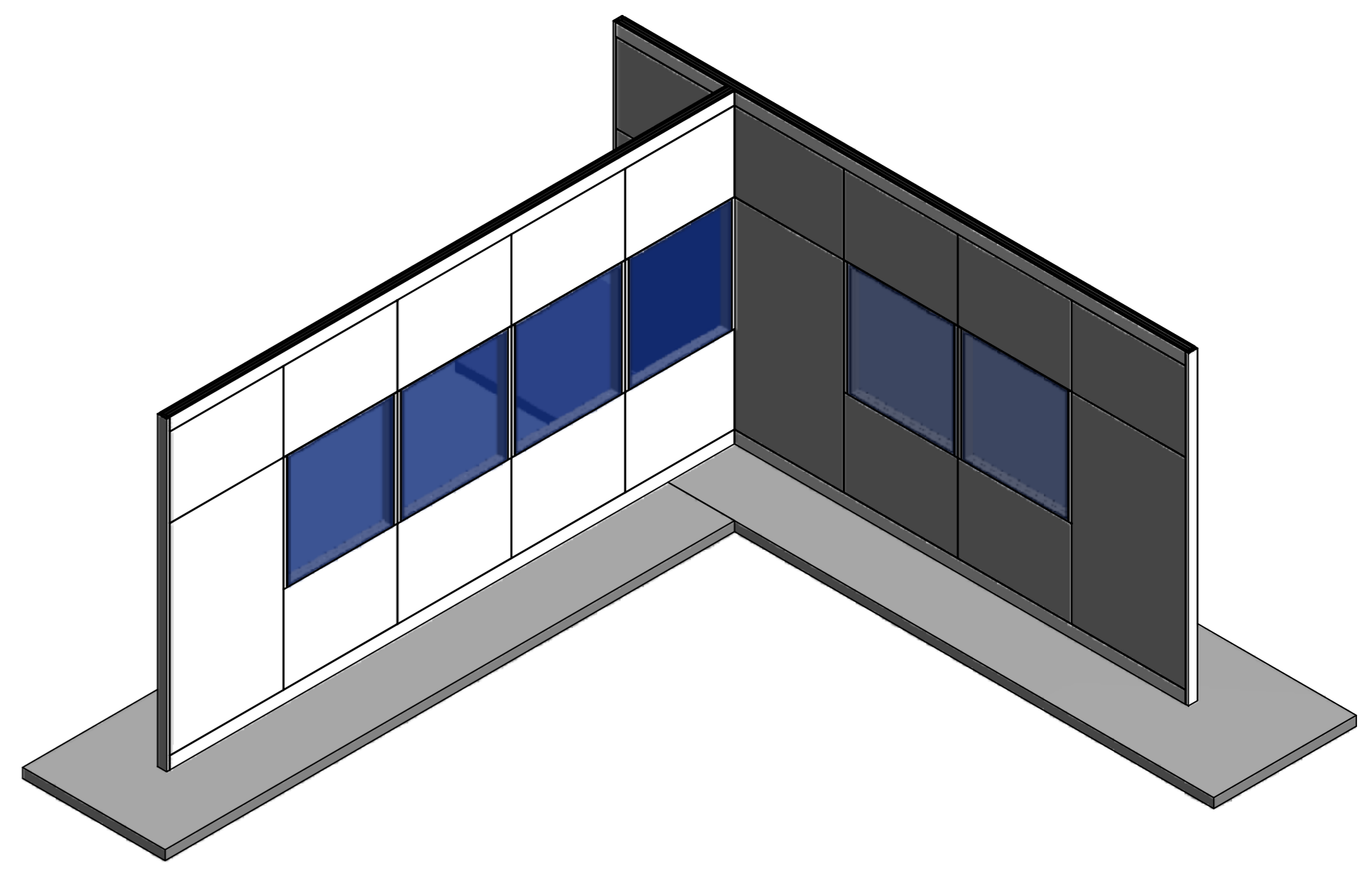
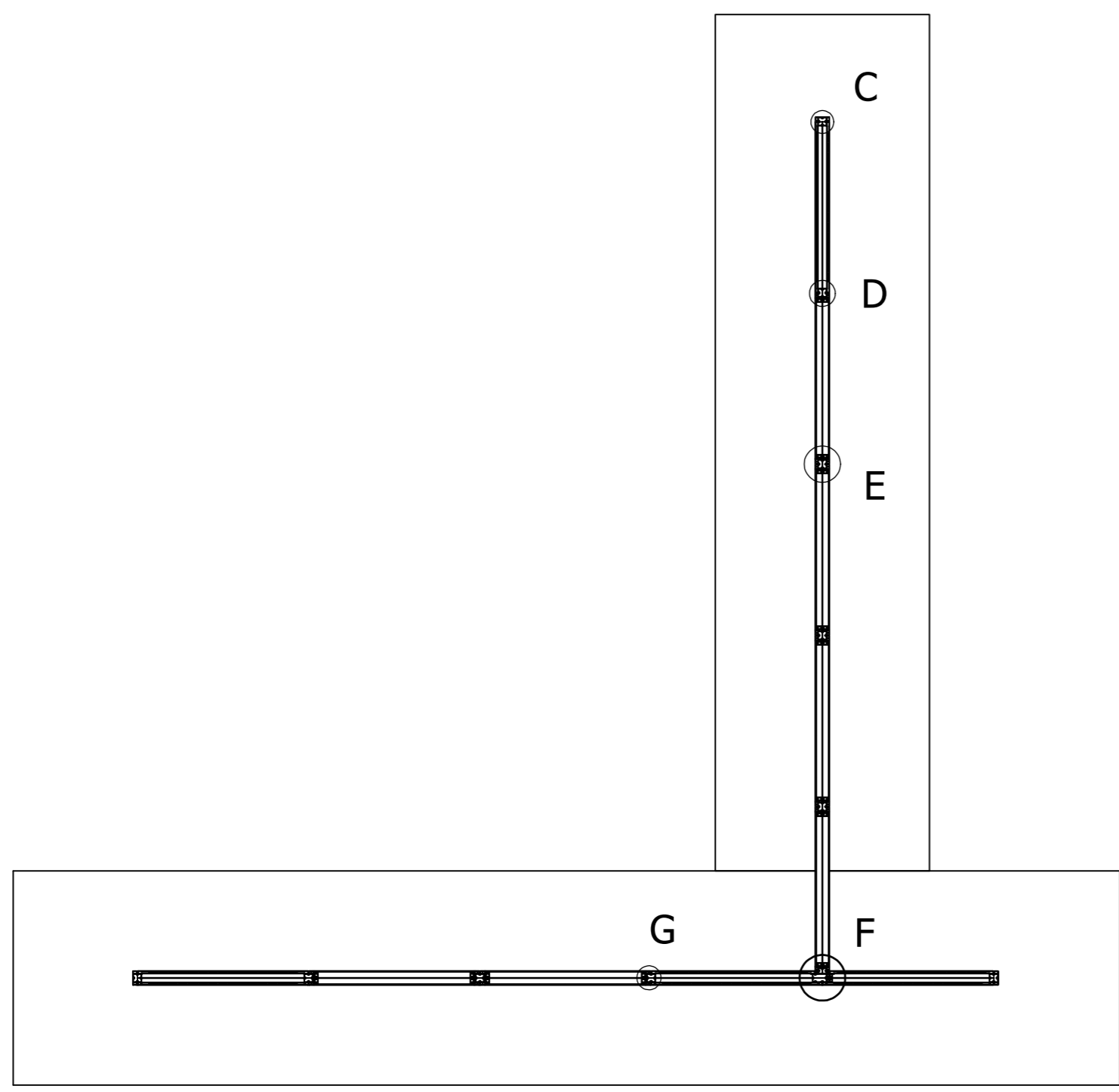
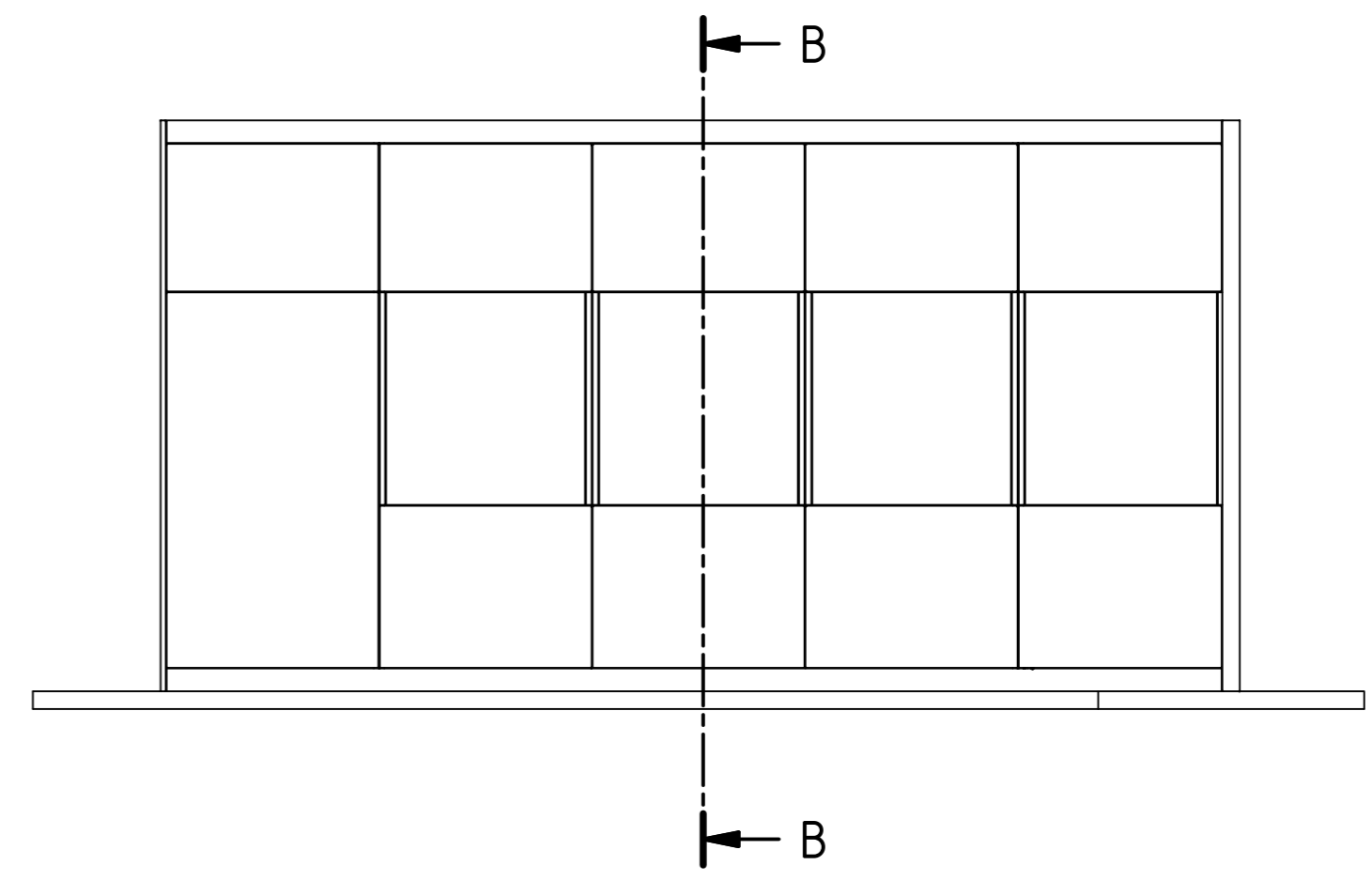

Alle Toleranzen nach DIN ISO 2768 mittel		Material		
<small>This drawing is our literary property and may neither be copied nor to be exposed approachable to third persons without our agreement; according to German Copyright Act</small>				
Gezeichnet	Datum	Name	Bezeichnung:	
Kontrolliert	31.07.2014	JK	Wandsystem OCV 98 mm	
Norm			Z-Nr: VRS_P98_10_0000	
Projekt Nr.			1	
Status	Änderungen	Datum	Name	A2

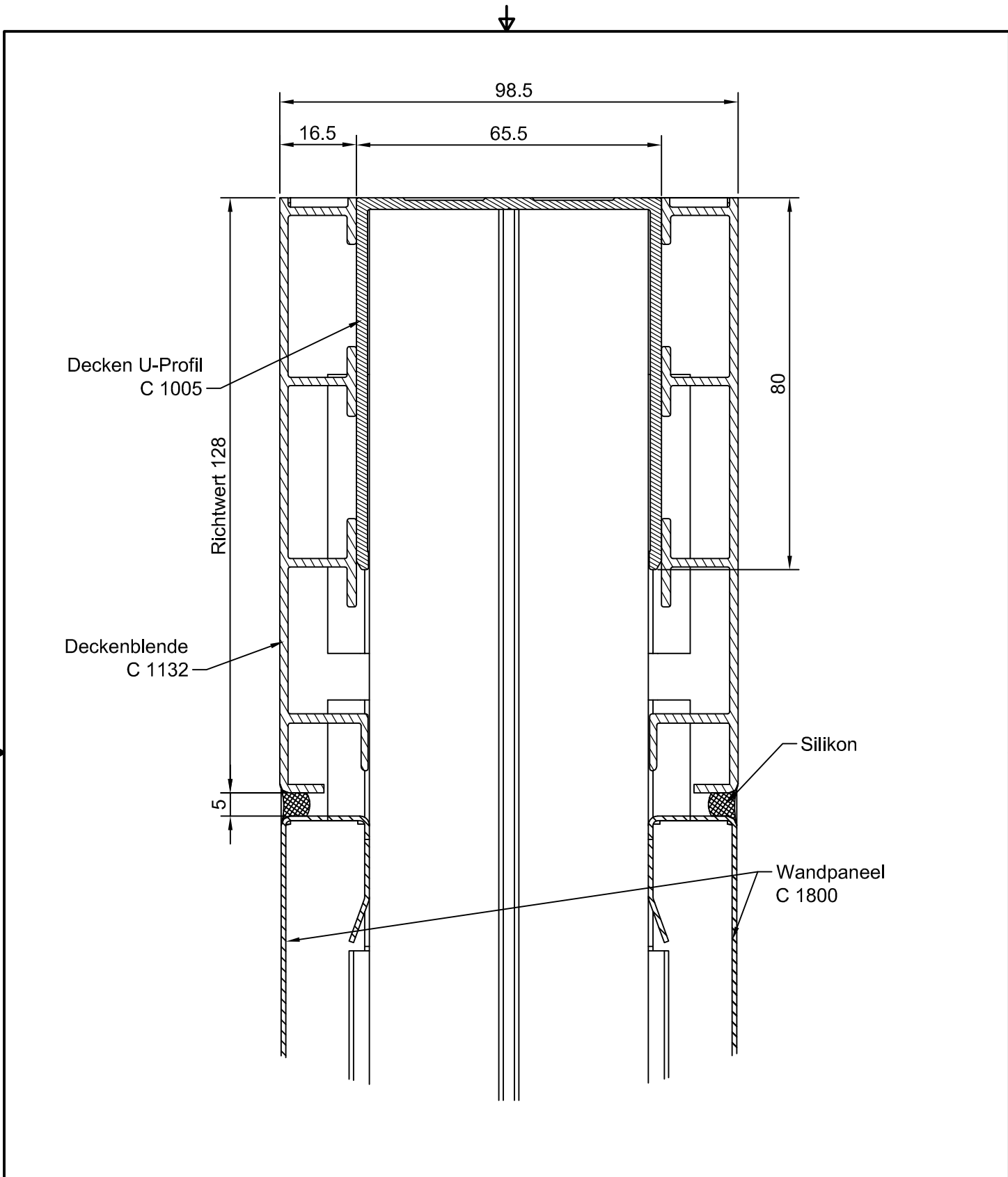

Alle Toleranzen nach DIN ISO 2768 mittel				Material		
This drawing is our literary property and may neither copied nor to be exposed approachable to third persons without our agreement; according to German Copyright Act						
				Datum	Name	Bezeichnung: Schnitt J: Deckenanschluss
				Gezeichnet	01.08.2014 jk	
				Kontrolliert		
				Norm		
				Projekt Nr.		Z-Nr: VRS_P98_11_0001
Status	Änderungen	Datum	Name			

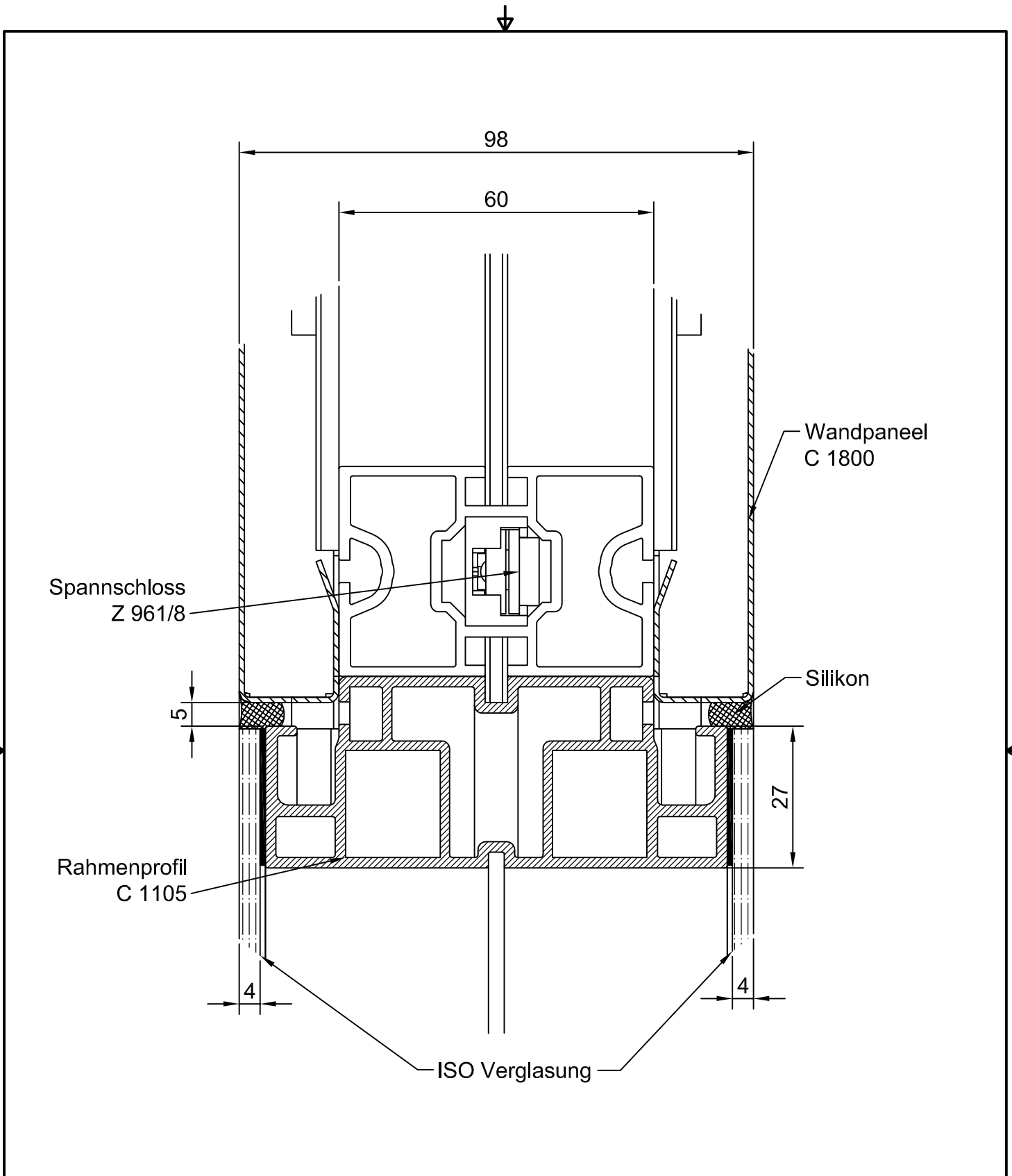

Alle Toleranzen nach DIN ISO 2768 mittel				Material		
This drawing is our literary property and may neither copied nor to be exposed approachable to third persons without our agreement; according to German Copyright Act						
				Datum	Name	Bezeichnung: Schnitt I: Verbindungsanschluss Paneel/ Glas
				Gezeichnet 01.08.2014	jk	
				Kontrolliert		
				Norm		
				Projekt Nr.		Z-Nr: VRS_P98_11_0002
Status	Änderungen	Datum	Name			

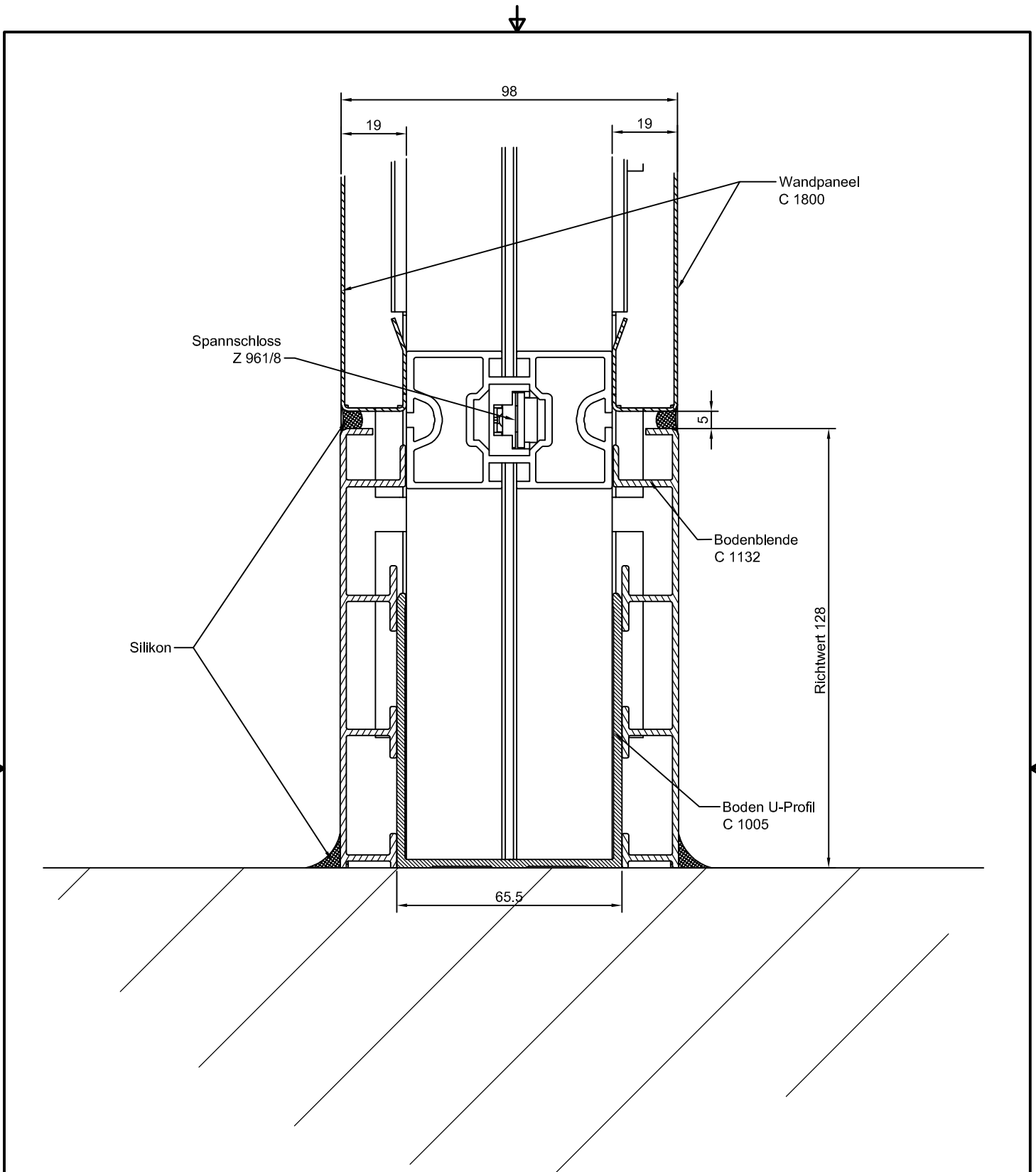

Alle Toleranzen nach DIN ISO 2768 mittel

Material



This drawing is our literary property and may neither copied nor to be exposed approachable to third persons without our agreement; according to German Copyright Act

				Datum	Name
				Gezeichnet 01.08.2014	jk
				Kontrolliert	
				Norm	
				Projekt Nr.	
Status	Änderungen	Datum	Name		

Bezeichnung:  
Schnitt H:  
Bodenanschluss Typ I

Z-Nr: VRS\_P98\_11\_0003

1  
A4

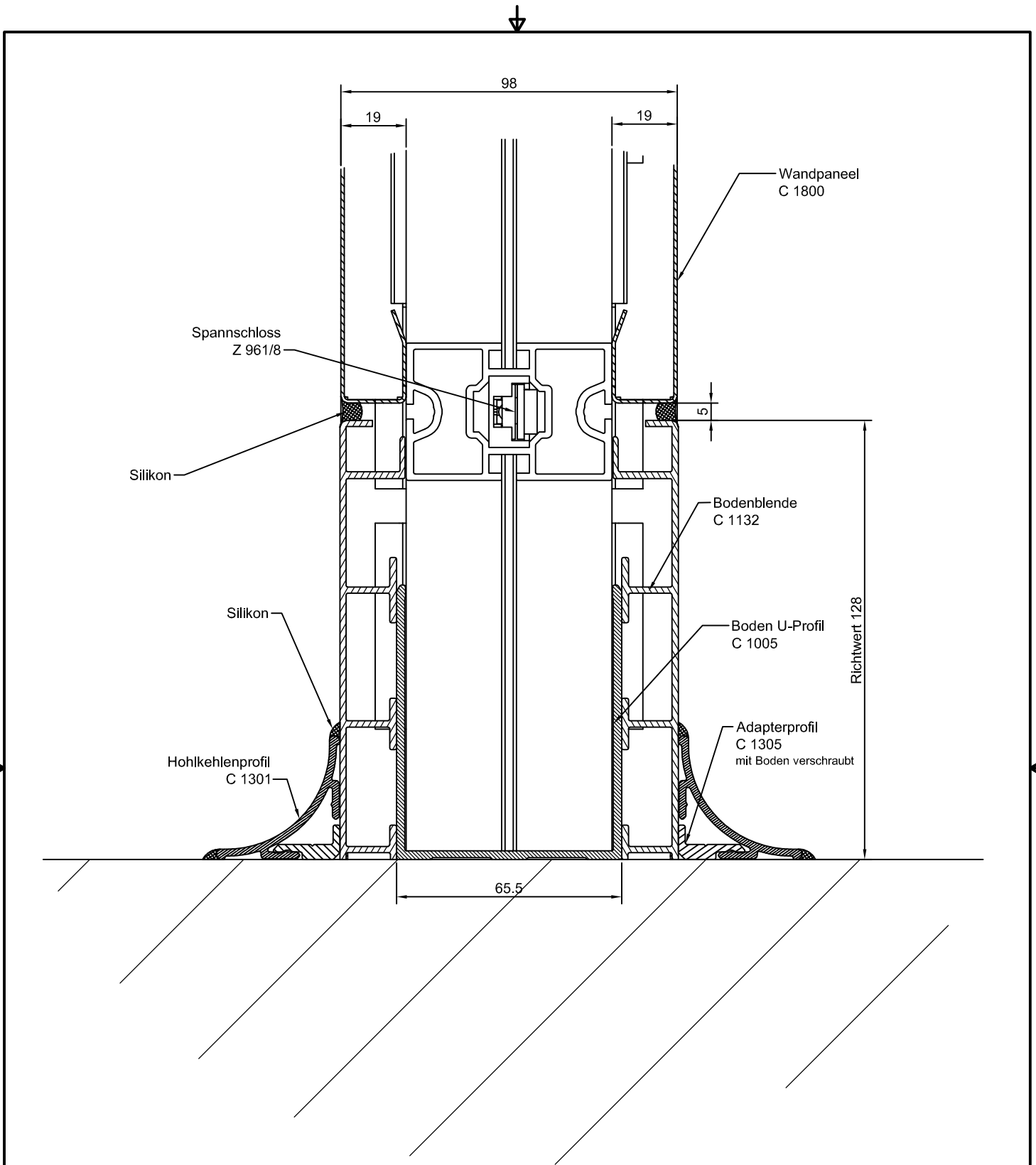

Alle Toleranzen nach DIN ISO 2768 mittel				Material			
This drawing is our literary property and may neither copied nor to be exposed approachable to third persons without our agreement; according to German Copyright Act							
				Datum	Name	Bezeichnung: Schnitt H: Bodenanschluss Typ II	
				Gezeichnet	01.08.2014		jk
				Kontrolliert			
				Norm			
				Projekt Nr.		Z-Nr: VRS_P98_11_0004	
							1 A4
Status	Änderungen	Datum	Name				

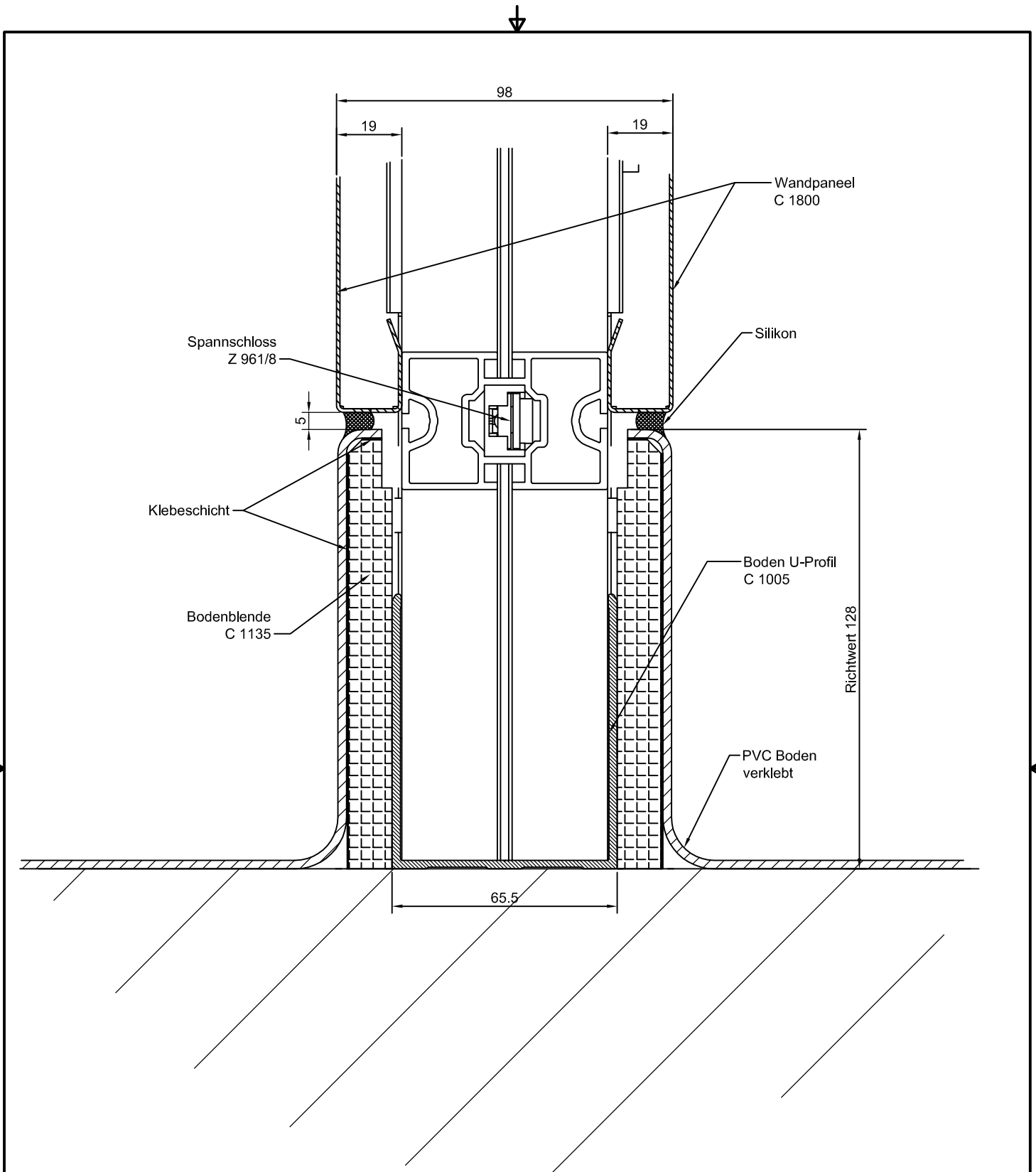

Alle Toleranzen nach DIN ISO 2768 mittel				Material			
This drawing is our literary property and may neither copied nor to be exposed approachable to third persons without our agreement; according to German Copyright Act							
				Datum	Name	Bezeichnung: Schnitt H: Bodenanschluss Typ III	
				Gezeichnet	01.08.2014		jk
				Kontrolliert			
				Norm			
				Projekt Nr.		Z-Nr: VRS_P98_11_0005	
							1 A4
Status	Änderungen	Datum	Name				

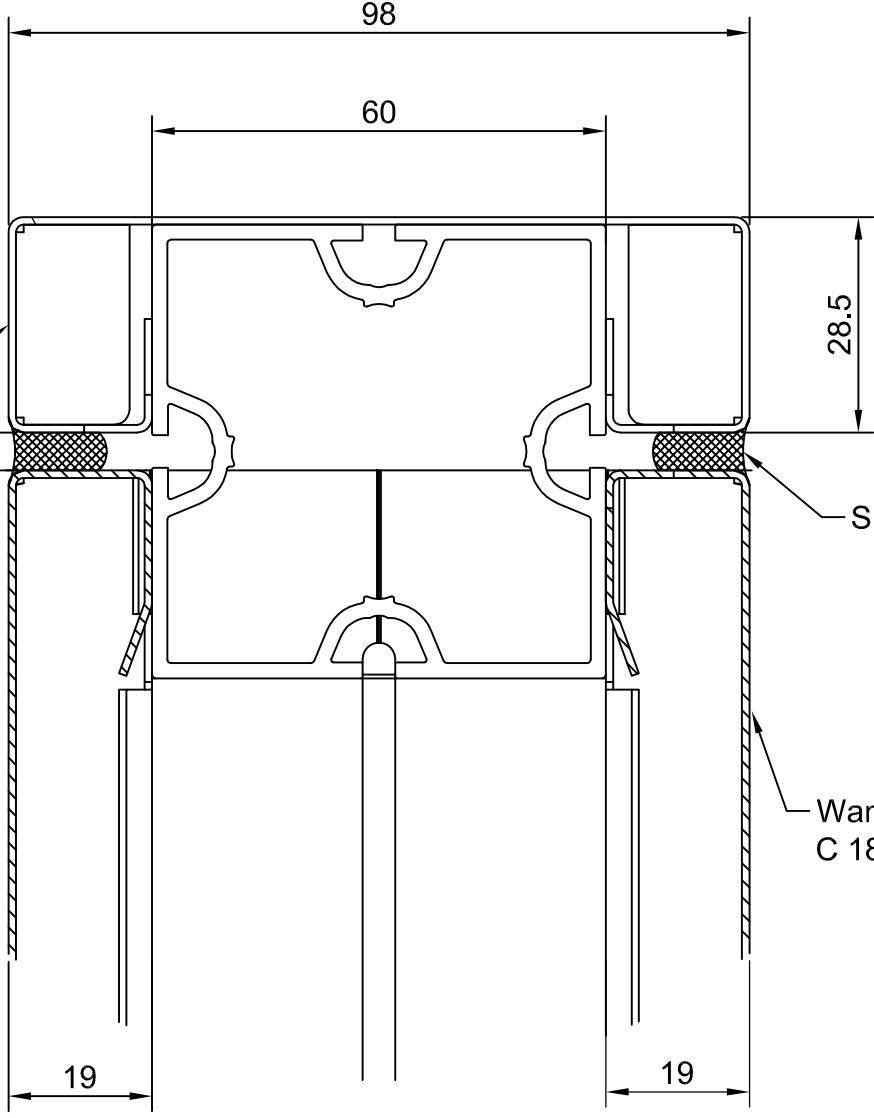

Abschlussblende  
C 1267

5

98

60

28.5

Silikon

Wandpaneel  
C 1800

19

19

Alle Toleranzen nach DIN ISO 2768 mittel

Material

This drawing is our literary property and may neither copied nor to be exposed approachable to third persons without our agreement; according to German Copyright Act



	Datum	Name
Gezeichnet	31.07.2014	jk
Kontrolliert		
Norm		

Bezeichnung:  
Schnitt C:  
Wandabschluss

Status	Änderungen	Datum	Name

Projekt Nr.

Z-Nr: VRS\_P98\_12\_0001

1  
A4





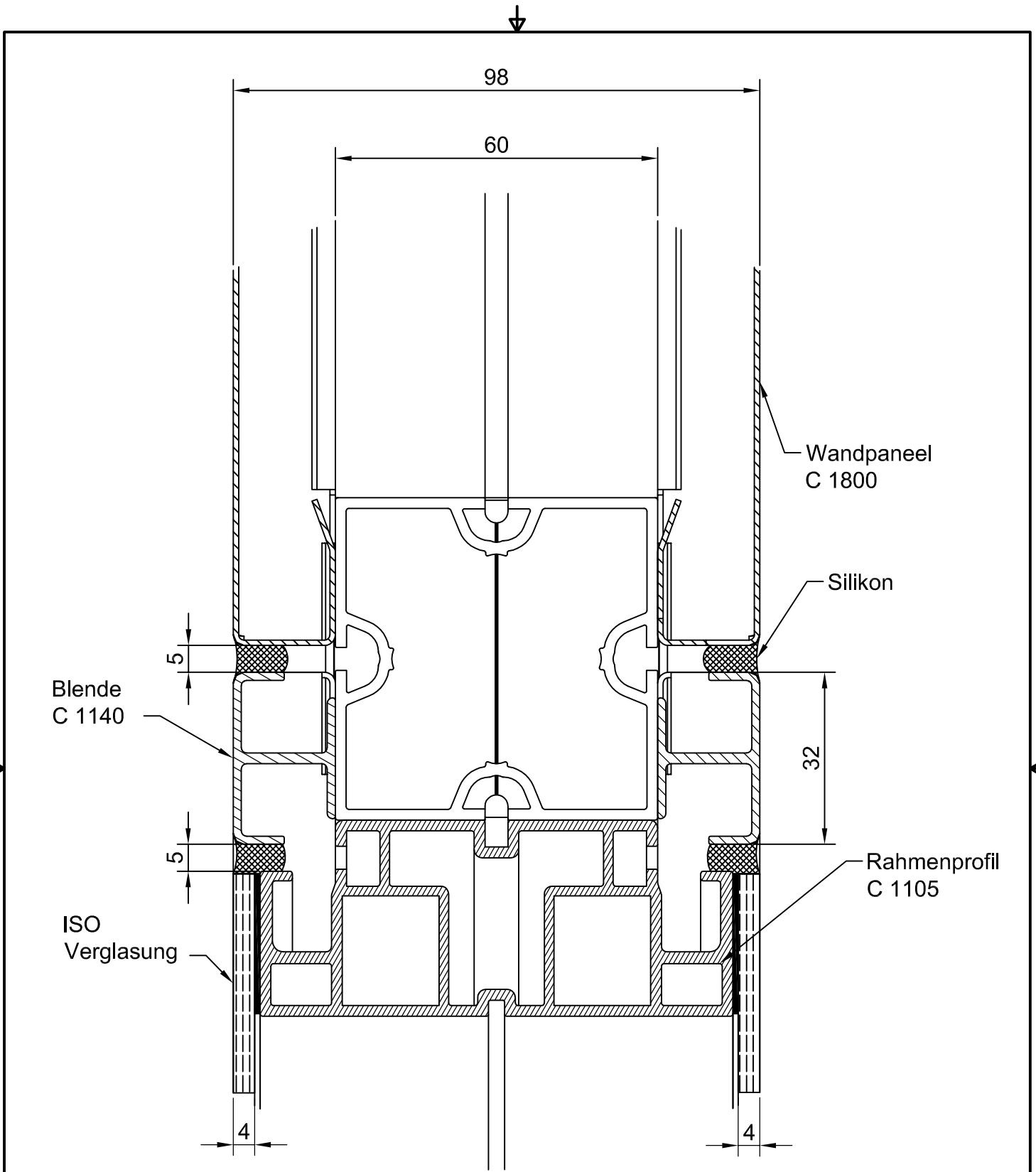

Alle Toleranzen nach DIN ISO 2768 mittel				Material			
This drawing is our literary property and may neither copied nor to be exposed approachable to third persons without our agreement; according to German Copyright Act							
				Datum	Name	Bezeichnung: Schnitt D: Verbindungsanschluss Paneel/ Glas	
				Gezeichnet	31.07.2014		jk
				Kontrolliert			
				Norm			
				Projekt Nr.		Z-Nr: VRS_P98_12_0002	
							1 A4
Status	Änderungen	Datum	Name				

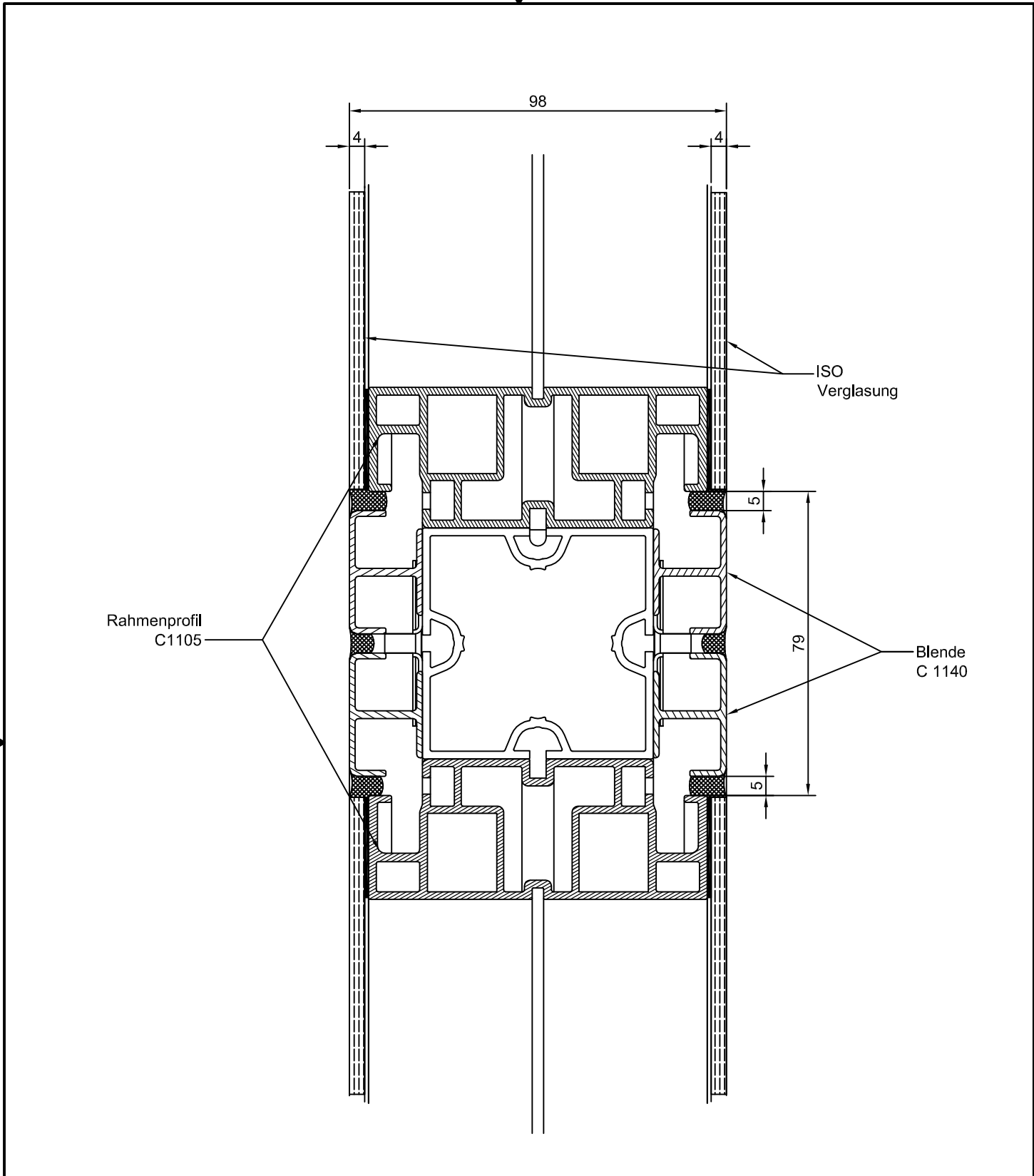

Alle Toleranzen nach DIN ISO 2768 mittel				Material			
This drawing is our literary property and may neither copied nor to be exposed approachable to third persons without our agreement; according to German Copyright Act							
				Datum	Name	Bezeichnung: Schnitt E: Verbindungsanschluss Glas/ Glas	
				Gezeichnet	31.07.2014		jk
				Kontrolliert			
				Norm			
				Projekt Nr.		Z-Nr: VRS_P98_12_0003	
							1 A4
Status	Änderungen	Datum	Name				



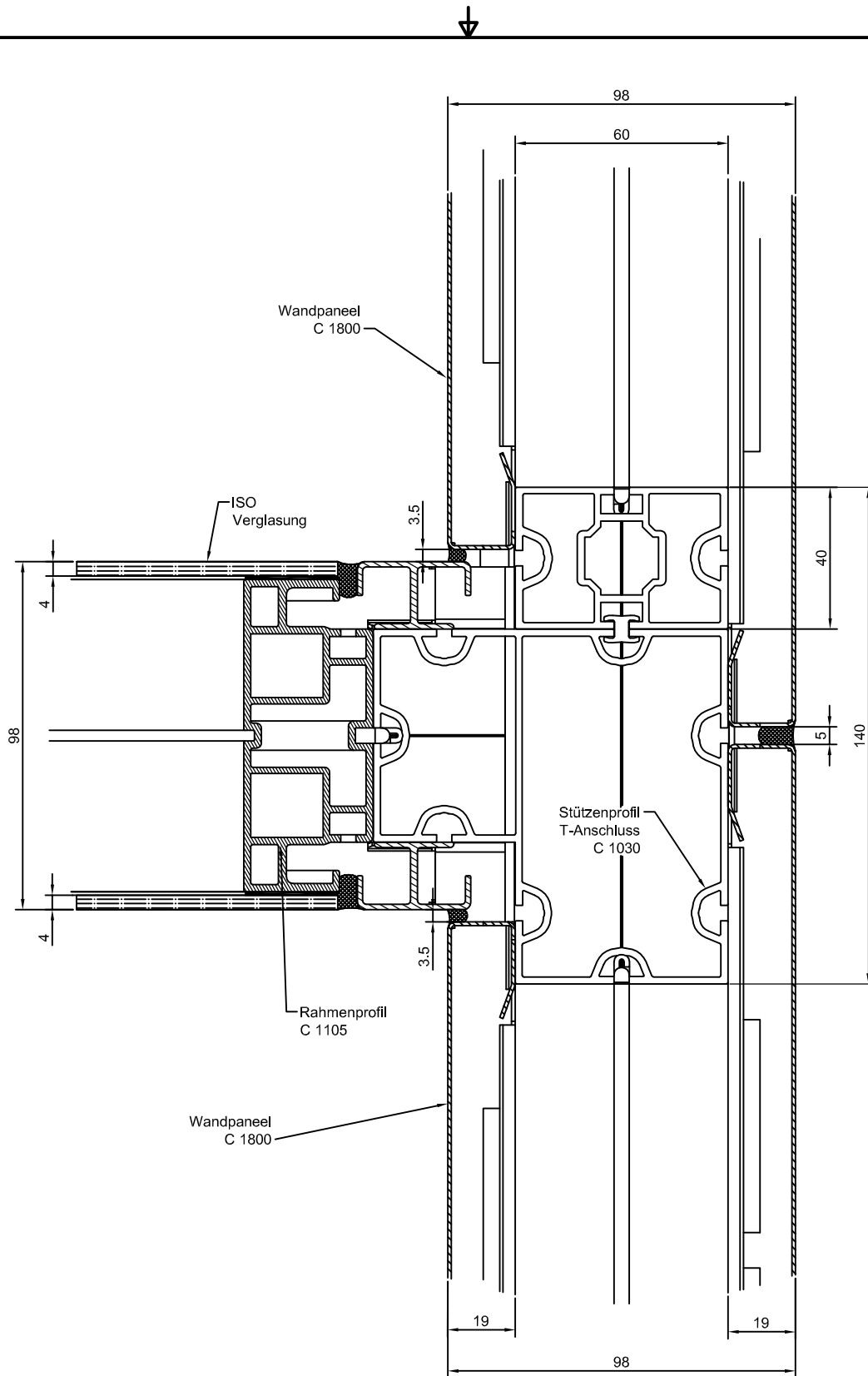

Alle Toleranzen nach DIN ISO 2768 mittel

This drawing is our literary property and may neither copied nor to be exposed approachable to third persons without our agreement; according to German Copyright Act

Material

**OCTANORM** 

	Datum	Name
Gezeichnet	31.07.2014	jk
Kontrolliert		
Norm		

Bezeichnung:  
Schnitt F:  
T - Anschluss Glas/ Paneel/ Pabeel

Status	Änderungen	Datum	Name

Projekt Nr.

Z-Nr: VRS\_P98\_12\_0004

1  
A4

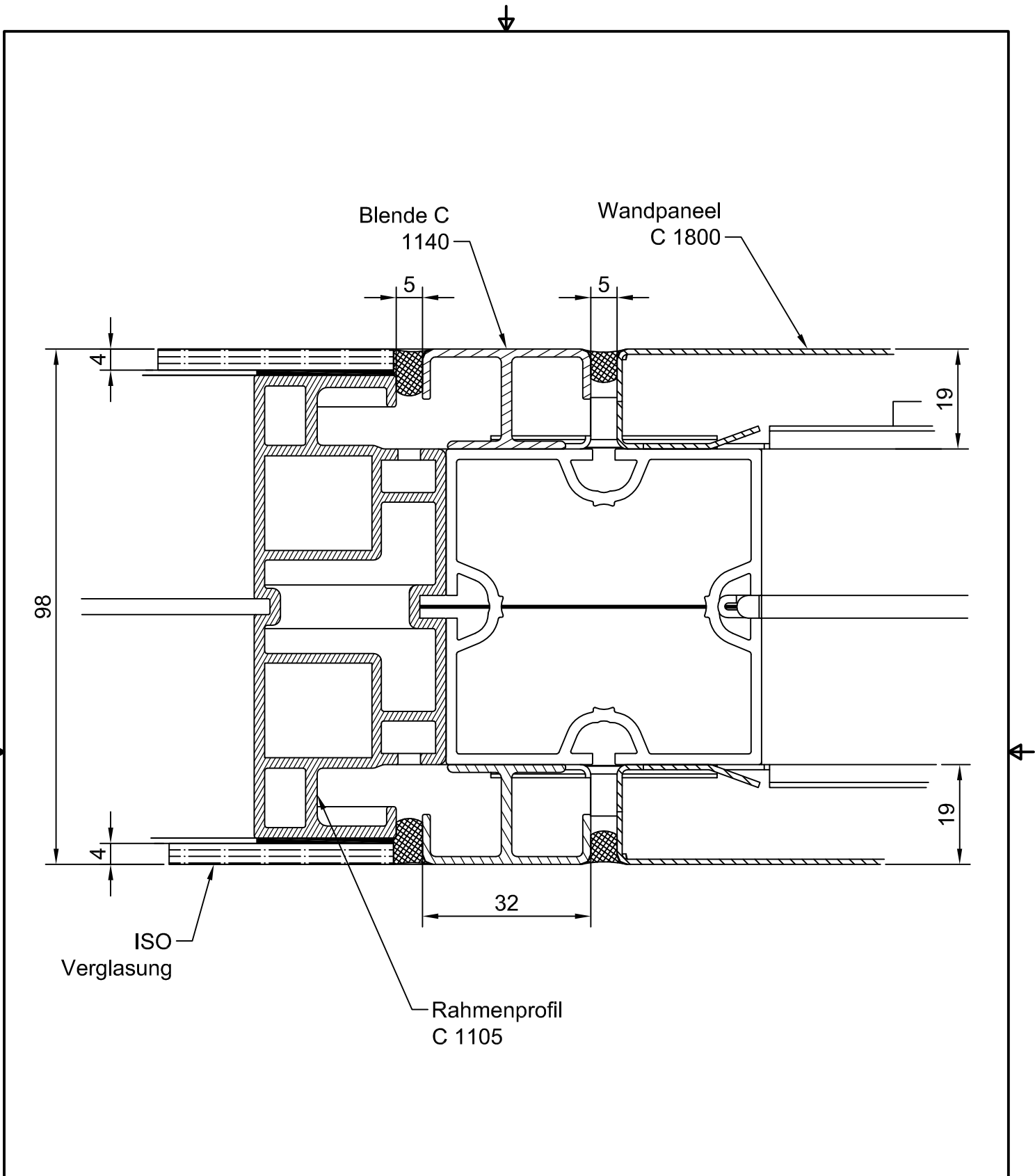

Alle Toleranzen nach DIN ISO 2768 mittel				Material			
This drawing is our literary property and may neither copied nor to be exposed approachable to third persons without our agreement; according to German Copyright Act							
				Datum	Name	Bezeichnung: Schnitt G: Verbindungsanschluss Paneel/ Glas	
				Gezeichnet	01.08.2014		jk
				Kontrolliert			
				Norm			
				Projekt Nr.		Z-Nr: VRS_P98_12_0005	
							1
Status	Änderungen	Datum	Name			A4	

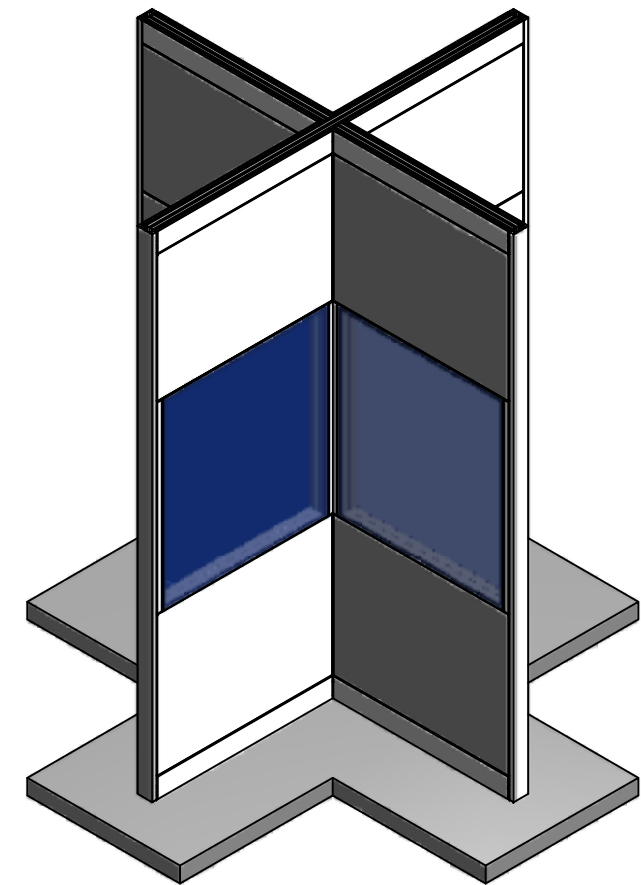
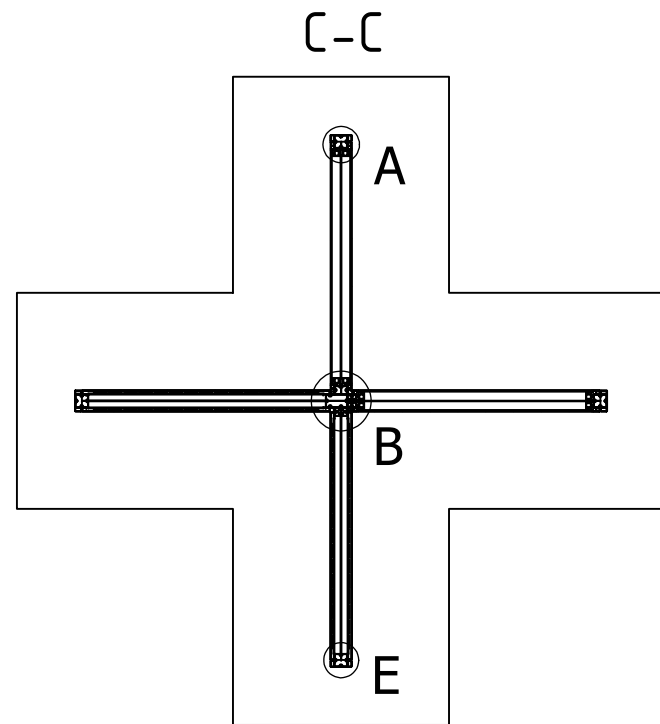
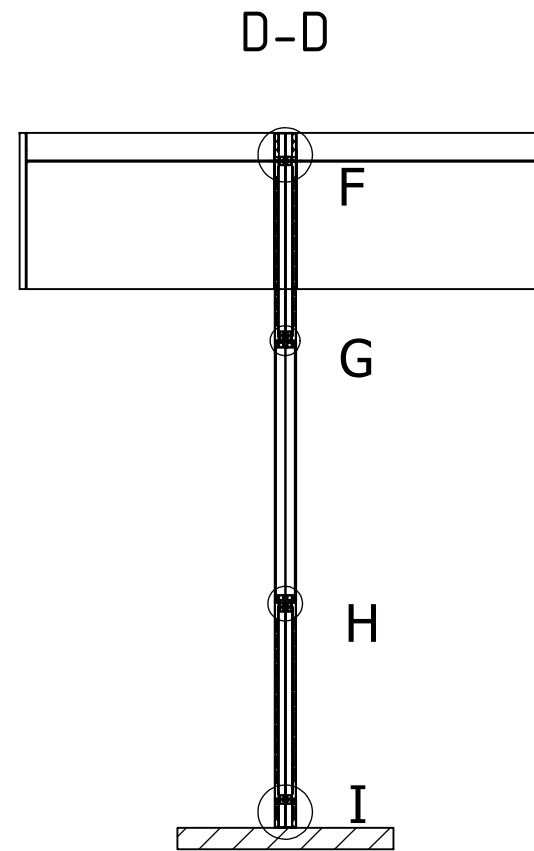
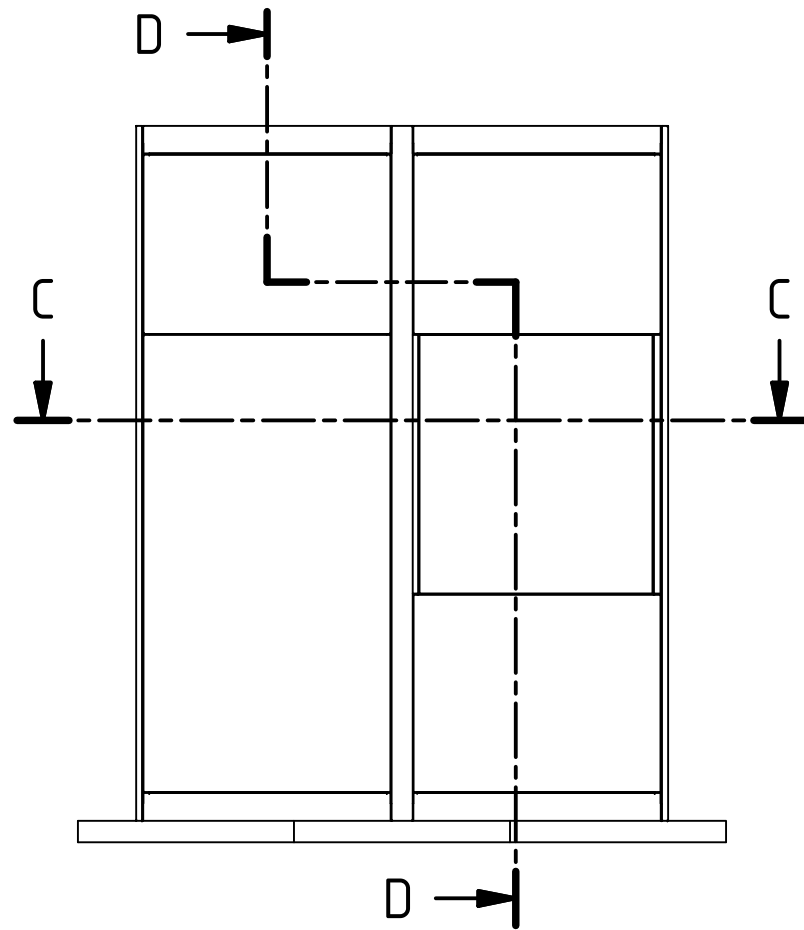

Alle Toleranzen nach DIN ISO 2768 mittel

This drawing is our literary property and may neither copied nor to be exposed approachable to third persons without our agreement; according to German Copyright Act

Material

Status	Änderungen	Datum	Name	Datum	Name
				Gezeichnet	01.08.2014 jk
				Kontrolliert	
				Norm	
				Projekt Nr.	

**OCTANORM** 

Bezeichnung:

Wansystem OCV 98 mm Wandkreuzung

Z-Nr:VRS\_P98\_20\_0000

1

A3

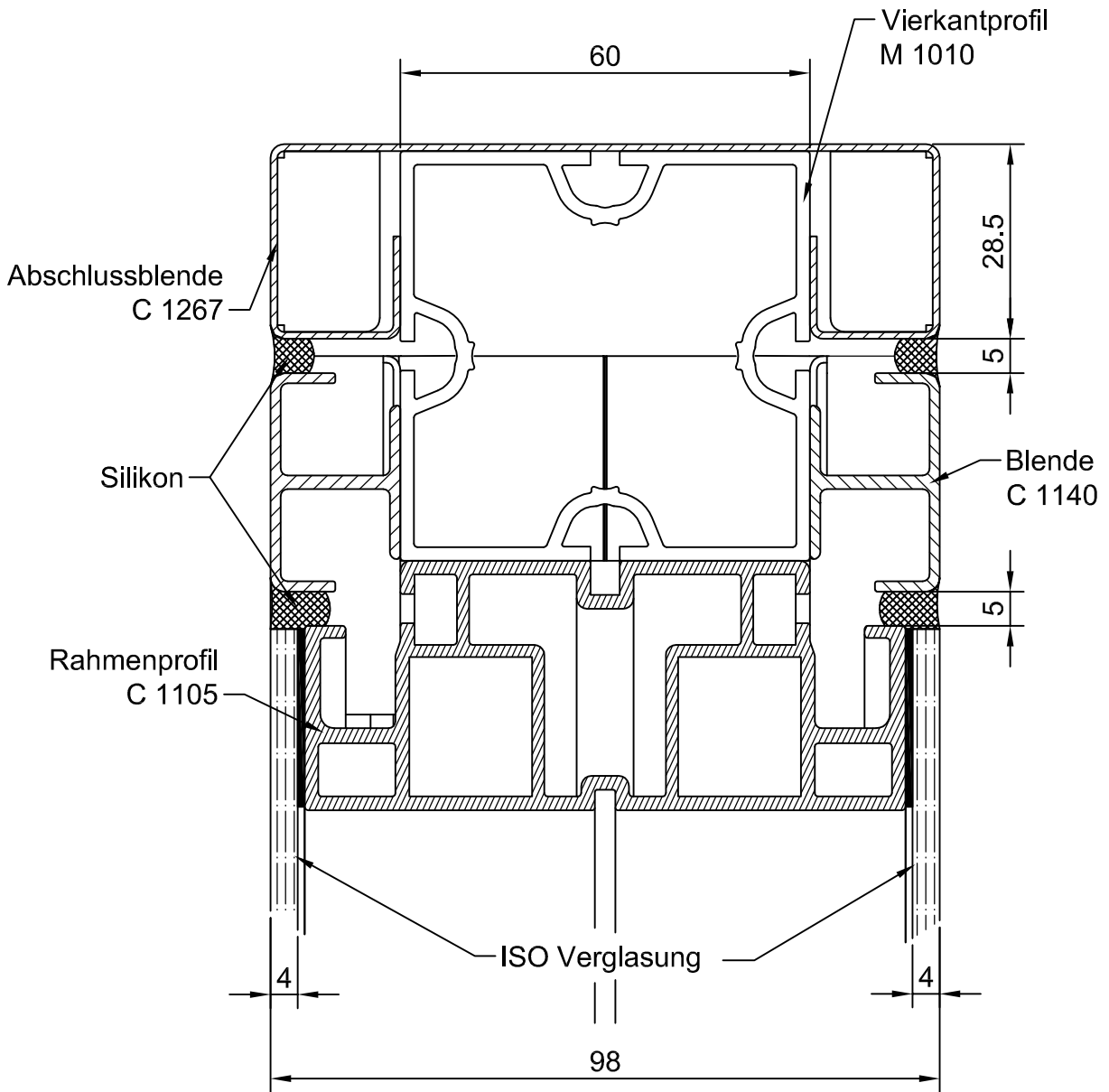

Alle Toleranzen nach DIN ISO 2768 mittel  
 This drawing is our literary property and may neither copied nor to be exposed approachable to third persons without our agreement; according to German Copyright Act

**Material**



				Datum	Name
				Gezeichnet 04.08.2014	jk
				Kontrolliert	
				Norm	

Bezeichnung:  
 Schnitt A:  
 Wandabschluss

				Projekt Nr.

Z-Nr: VRS\_P98\_22\_0001

1
A4

Status	Änderungen	Datum	Name

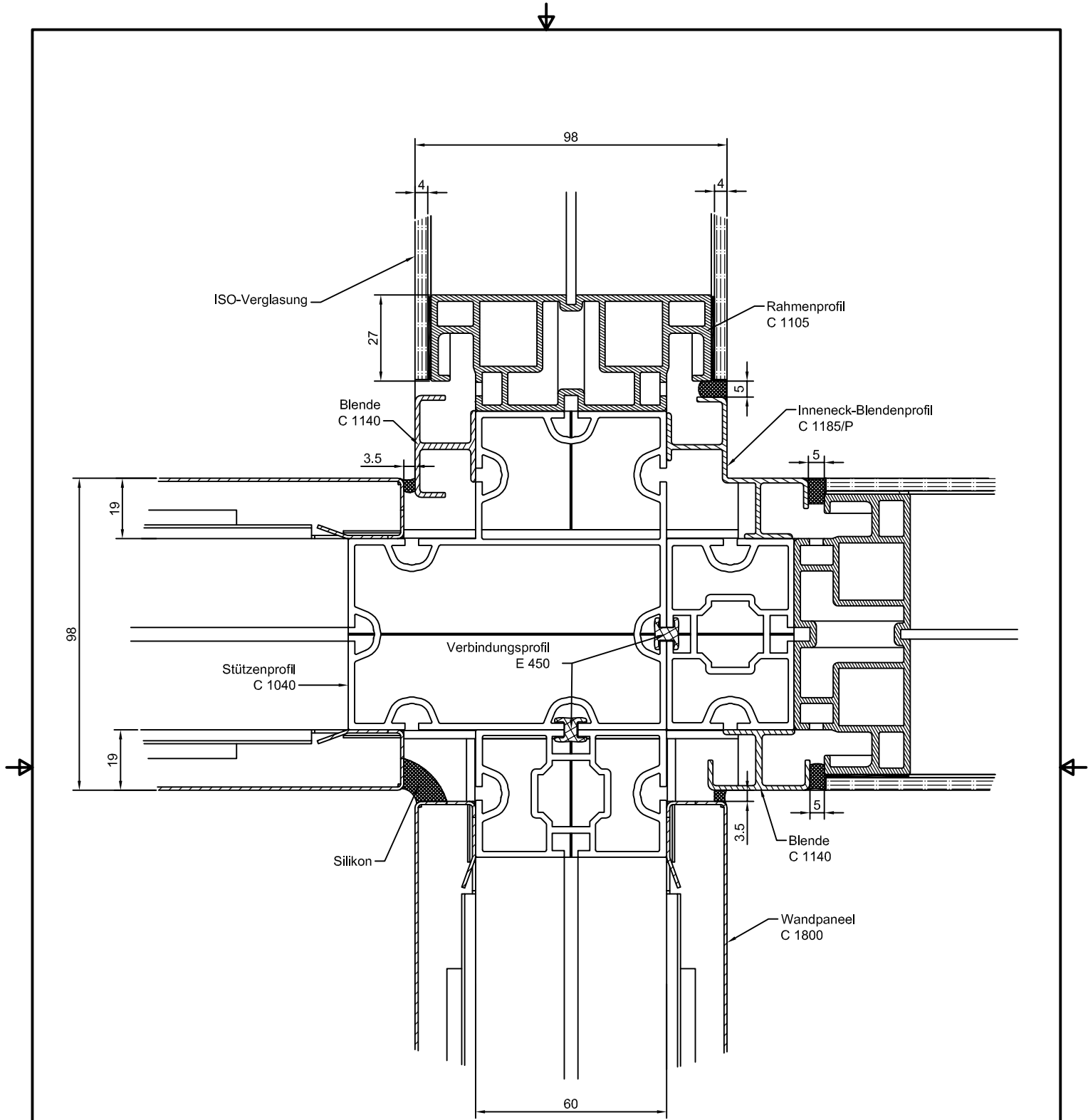

Alle Toleranzen nach DIN ISO 2768 mittel

This drawing is our literary property and may neither copied nor to be exposed approachable to third persons without our agreement; according to German Copyright Act

Material

**OCTANORM** 

	Datum	Name
Gezeichnet	04.08.2014	jk
Kontrolliert		
Norm		

Bezeichnung:

Schnitt B:  
Kreuz-Anschluss Paneel/ Paneel/ Glas/ Glas

Projekt Nr.			

Z-Nr: VRS\_P98\_22\_0002

1  
A4

Status	Änderungen	Datum	Name

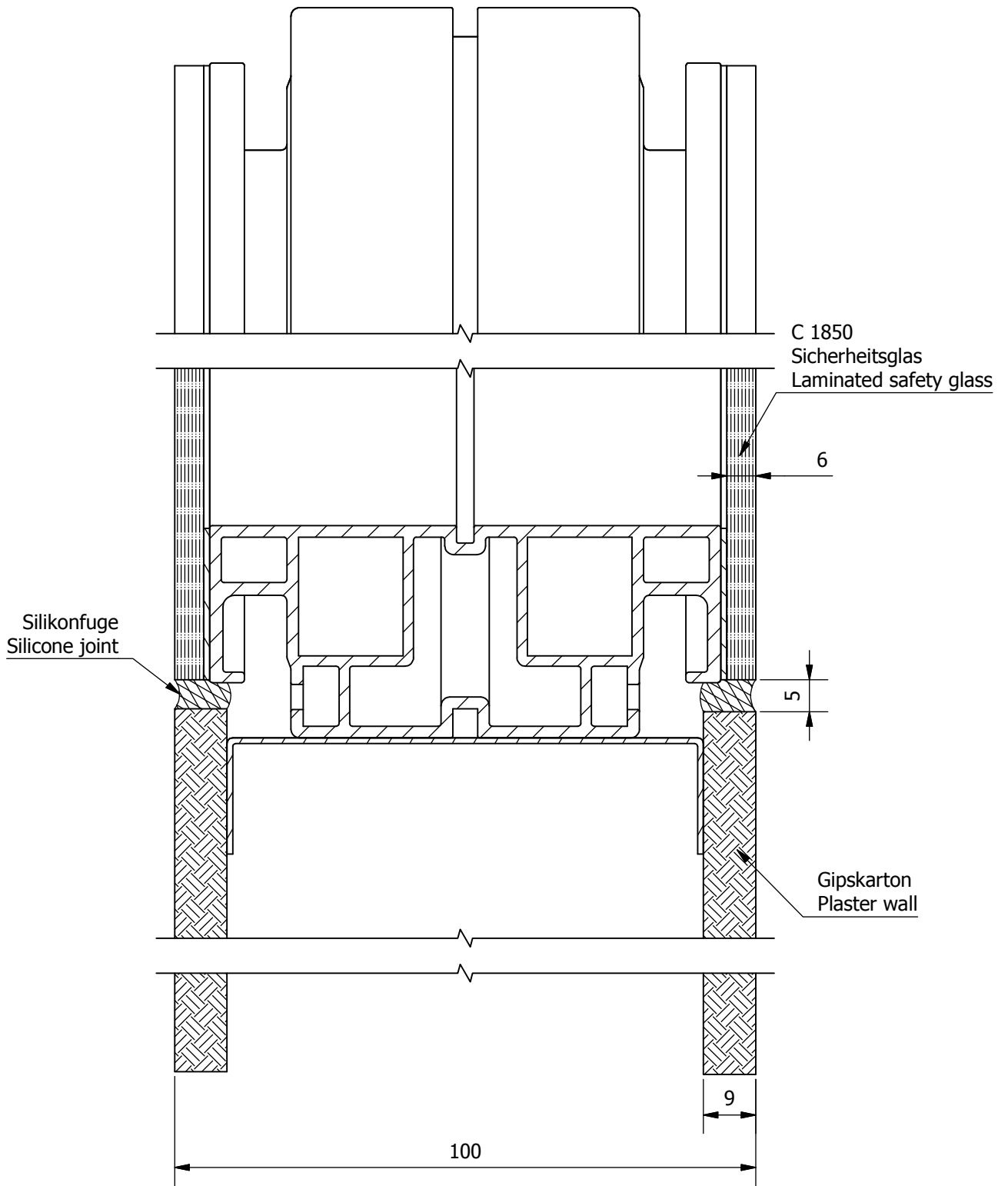

Alle Toleranzen nach DIN ISO 2768 mittel

Material

**OCTANORM** 

This drawing is our literary property and may neither copied nor to be exposed approachable to third persons without our agreement; according to German Copyright Act

Description / Bezeichnung:

Wandanschluss Verglasung/ Gipskarton  
Wall connection glazing/ plaster panel

		Datum	Name
	Gezeichnet	02.12.2014	jk
	Kontrolliert		
	Norm		
Projekt Nr.			
Status	Änderungen	Datum	Name

Z-Nr:VRS\_P98\_30\_0001

1

A4