



# TECHNICAL INFORMATION

## OCTANORM CLEANROOM SYSTEMS

PHARMACEUTICAL AND MEDICAL ENGINEERING  
Ceiling systems up to 100kg/m<sup>2</sup>

Technical data sheet

Linear grid ceiling PD1

THE  
WORLD  
OF  
SYSTEMS

OCTANORM 



# TECHNICAL DATA SHEET

## CEILING SYSTEM PD 1

Ceiling system with suspended steel sheet panels Linear grid ceiling	
Panel	Steel sheet, rock wool
Standard color	RAL 9010
Surface of beam / extrusion	Steel sheet, galvanized
Standard grid	max. 1200 × 1200 mm
Walkable	Yes, only for panels with rock wool

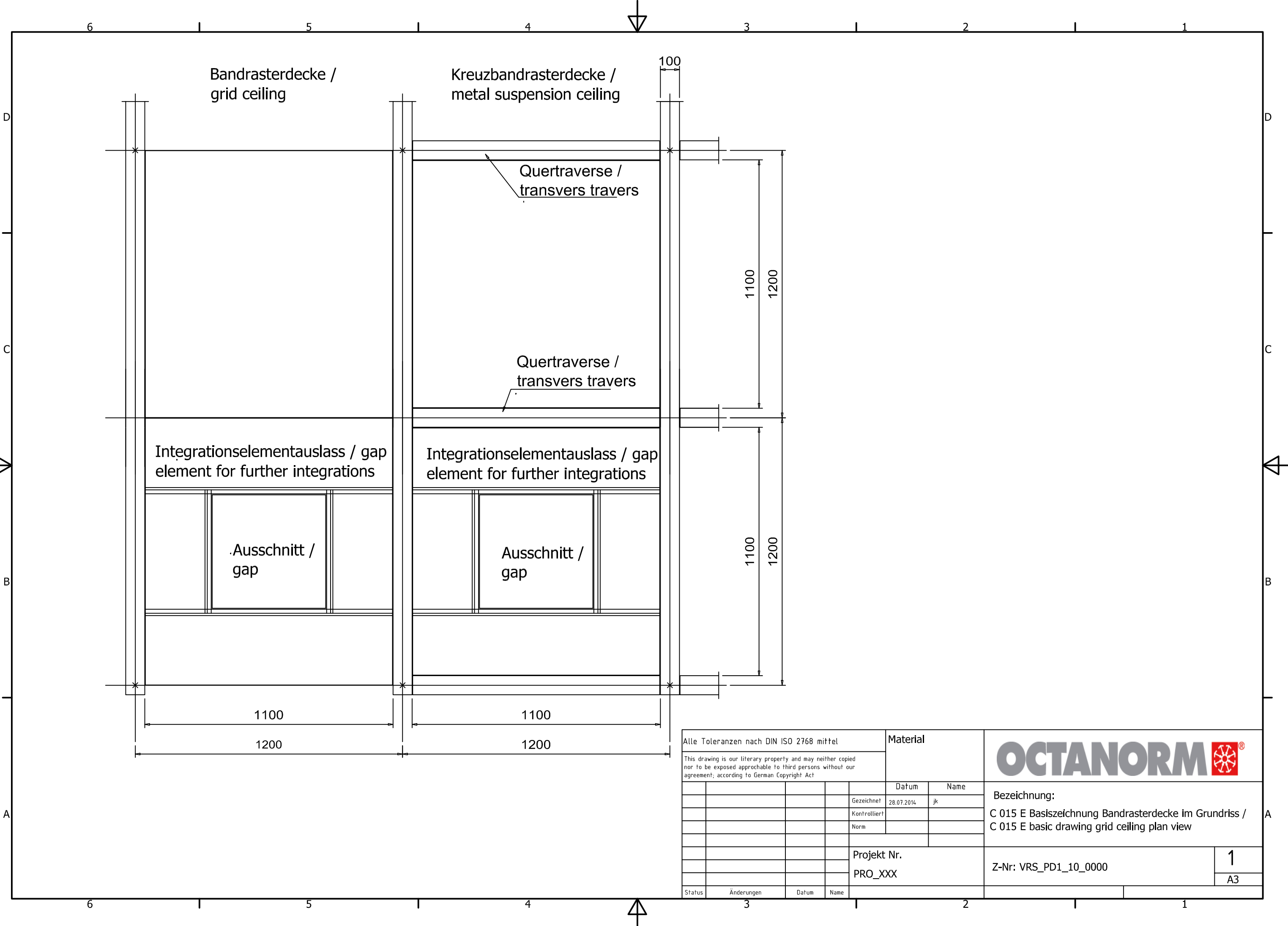

Alle Toleranzen nach DIN ISO 2768 mittel				Material	
This drawing is our literary property and may neither copied nor to be exposed approachable to third persons without our agreement; according to German Copyright Act				Datum	Name
				Gezeichnet	28.07.2014 jk
				Kontrolliert	
				Norm	
				Projekt Nr.	
				PRO_XXX	
Status	Änderungen	Datum	Name		



Bezeichnung:  
C 015 E Basiszeichnung Bandrasterdecke im Grundriss /  
C 015 E basic drawing grid ceiling plan view

Z-Nr: VRS\_PD1\_10\_0000

1  
A3

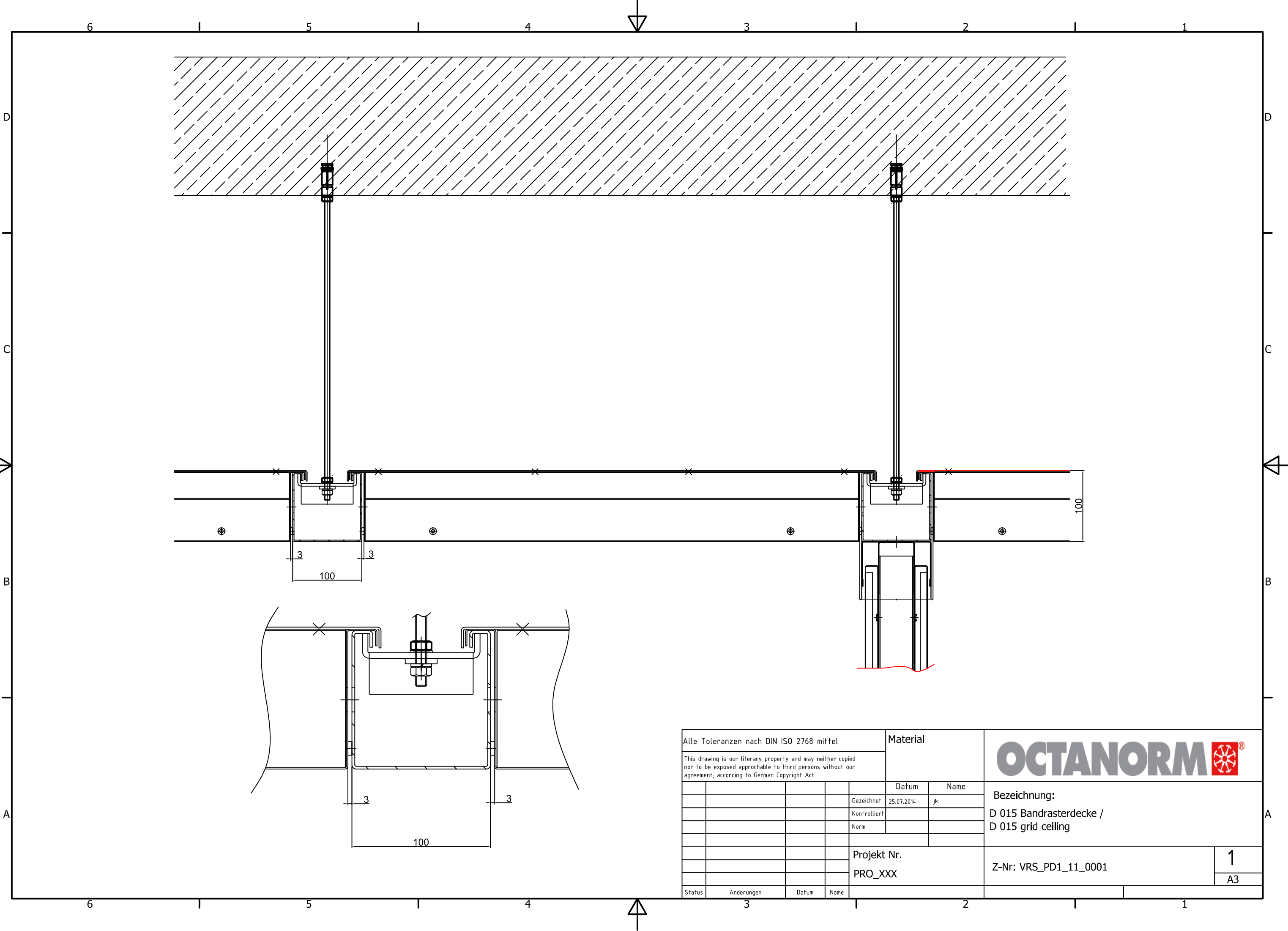

Alle Toleranzen nach DIN ISO 2768 mittel				Material	
This drawing is our literary property and may neither copied nor to be exposed approachable to third persons without our agreement; according to German Copyright Act					
				Datum	Name
			Gezeichnet	25.07.2014	jk
			Kontrolliert		
			Norm		
				Projekt Nr.	
				PRO_XXX	
Status	Änderungen	Datum	Name		

**OCTANORM** 

Bezeichnung:  
D 015 Bandrasterdecke /  
D 015 grid ceiling

Z-Nr: VRS\_PD1\_11\_0001

1  
A3

# Schnitt B-B / section B-B

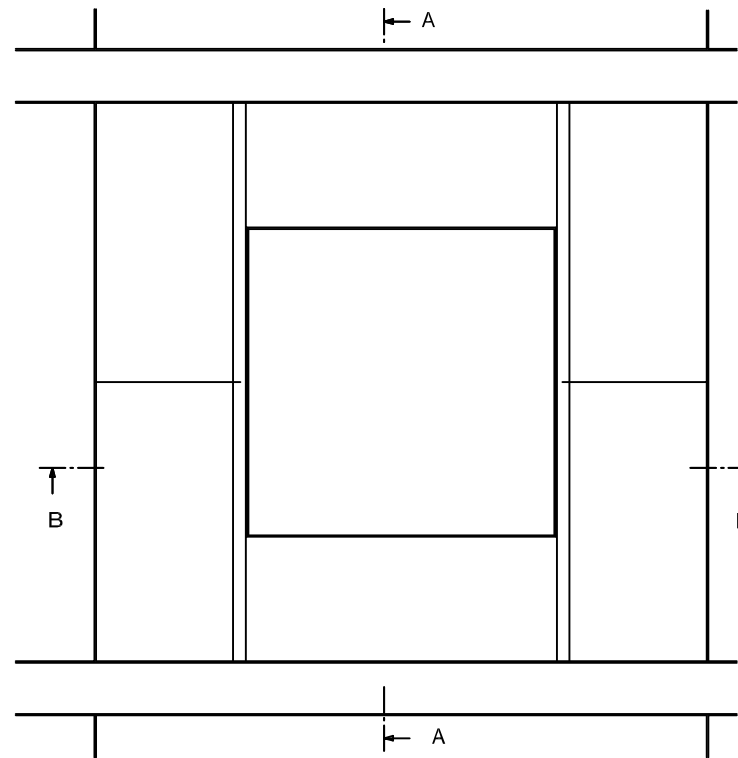
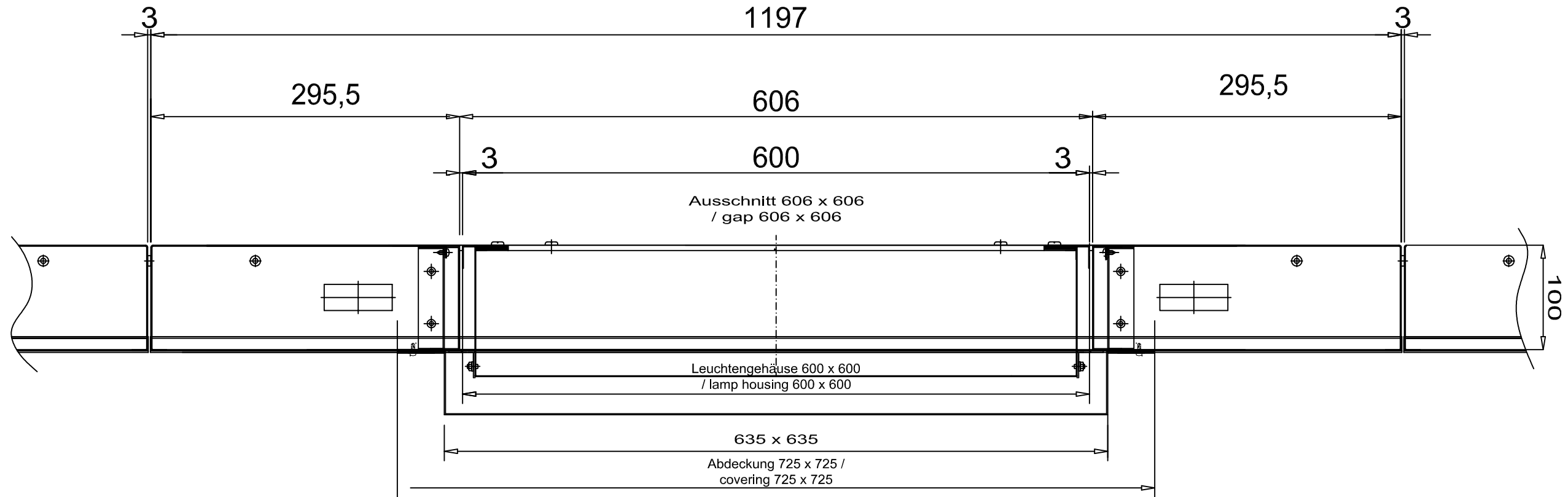

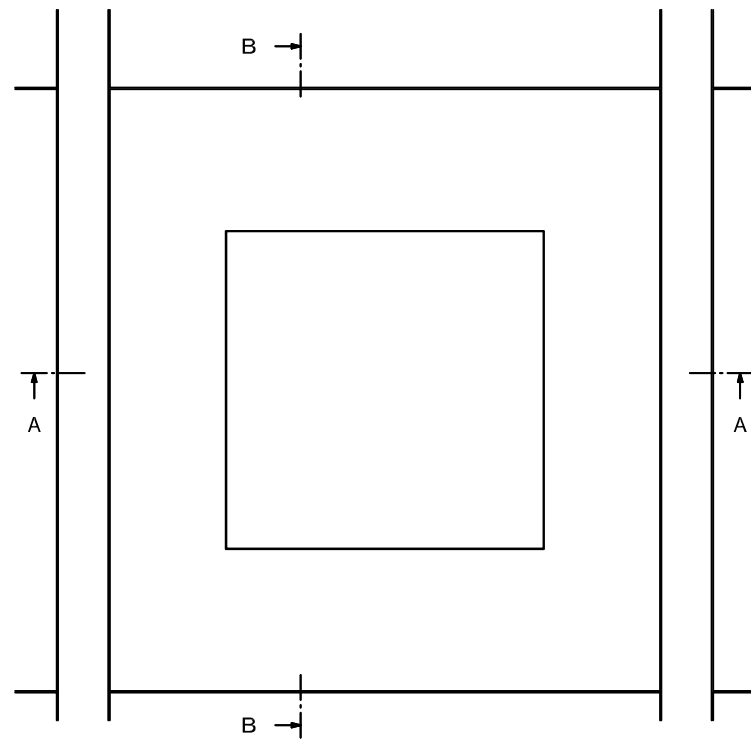
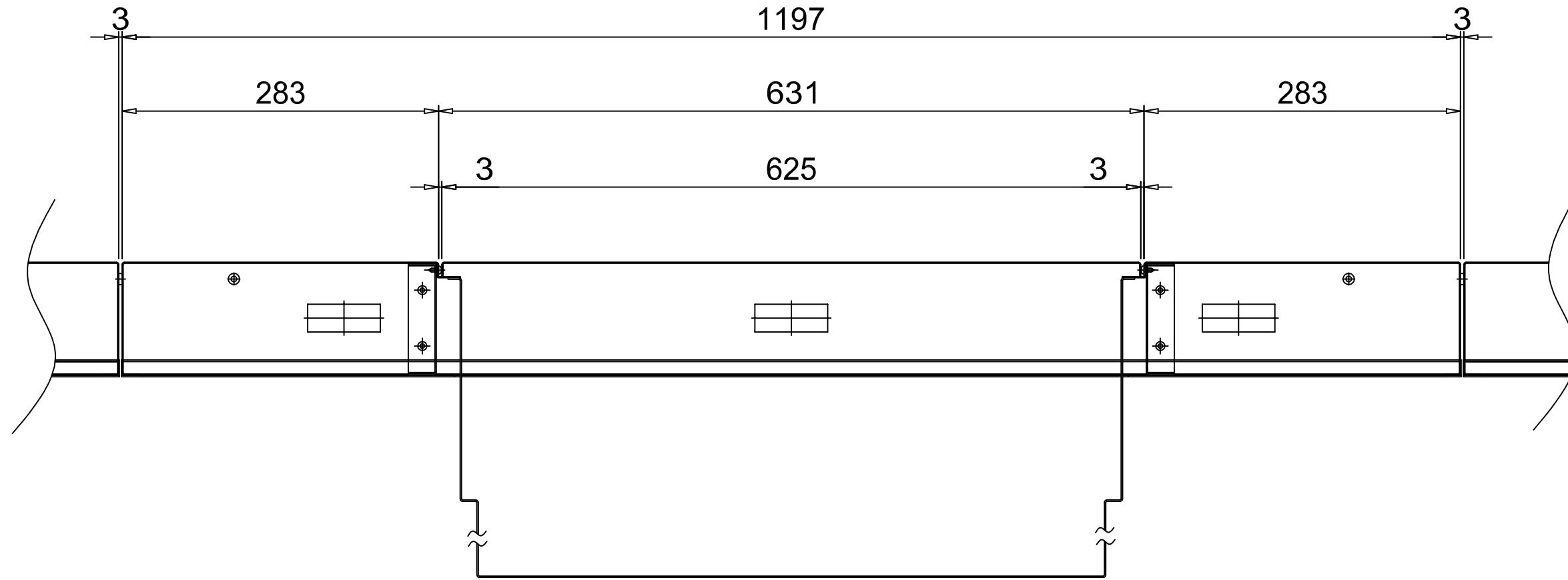

Alle Toleranzen nach DIN ISO 2768 mittel				Material		
This drawing is our literary property and may neither copied nor to be exposed approachable to third persons without our agreement; according to German Copyright Act						
				Datum	Name	Bezeichnung: C 015 A Deckenauschnitt mit Leuchte C 015 A Deckenauschnitt with lamp
				Gezeichnet	28.07.2014 jk	
				Kontrolliert		
				Norm		Z-Nr: VRS_PD1_11_0002
				Projekt Nr.	PRO_XXX	
Status	Änderungen	Datum	Name			1 A3

# Schnitt B-B

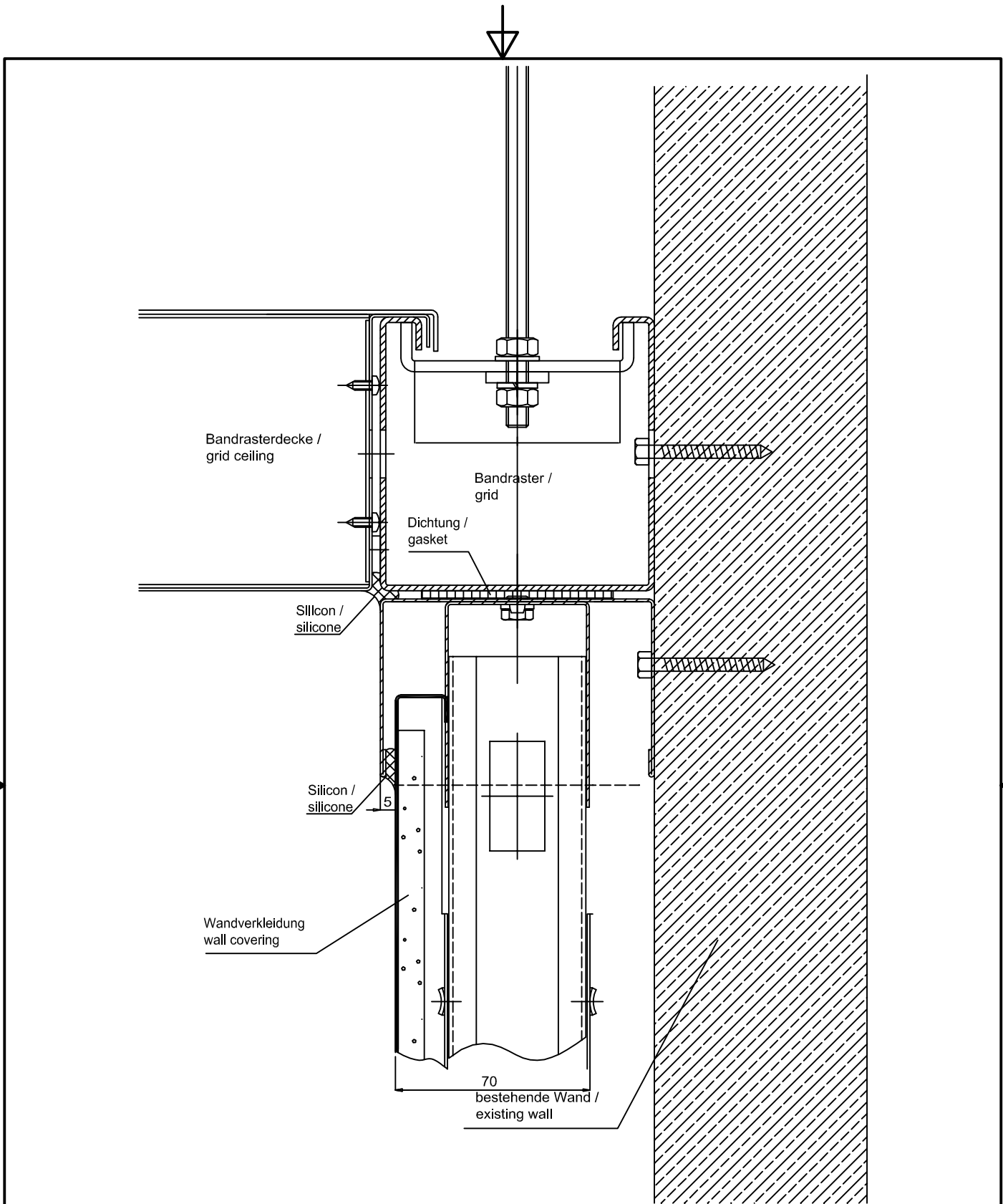

Alle Toleranzen nach DIN ISO 2768 mittel				Material		
This drawing is our literary property and may neither copied nor to be exposed approachable to third persons without our agreement; according to German Copyright Act						
				Datum	Name	Bezeichnung: C 015 B Deckenausschnitt mit Lüftung / C 015 B ceiling gap for ventilation
				Gezeichnet	28.07.2014 jk	
				Kontrolliert		
				Norm		Z-Nr: VRS_PD1_11_0003
				Projekt Nr.	PRO_XXX	
Status	Änderungen	Datum	Name			1 A3



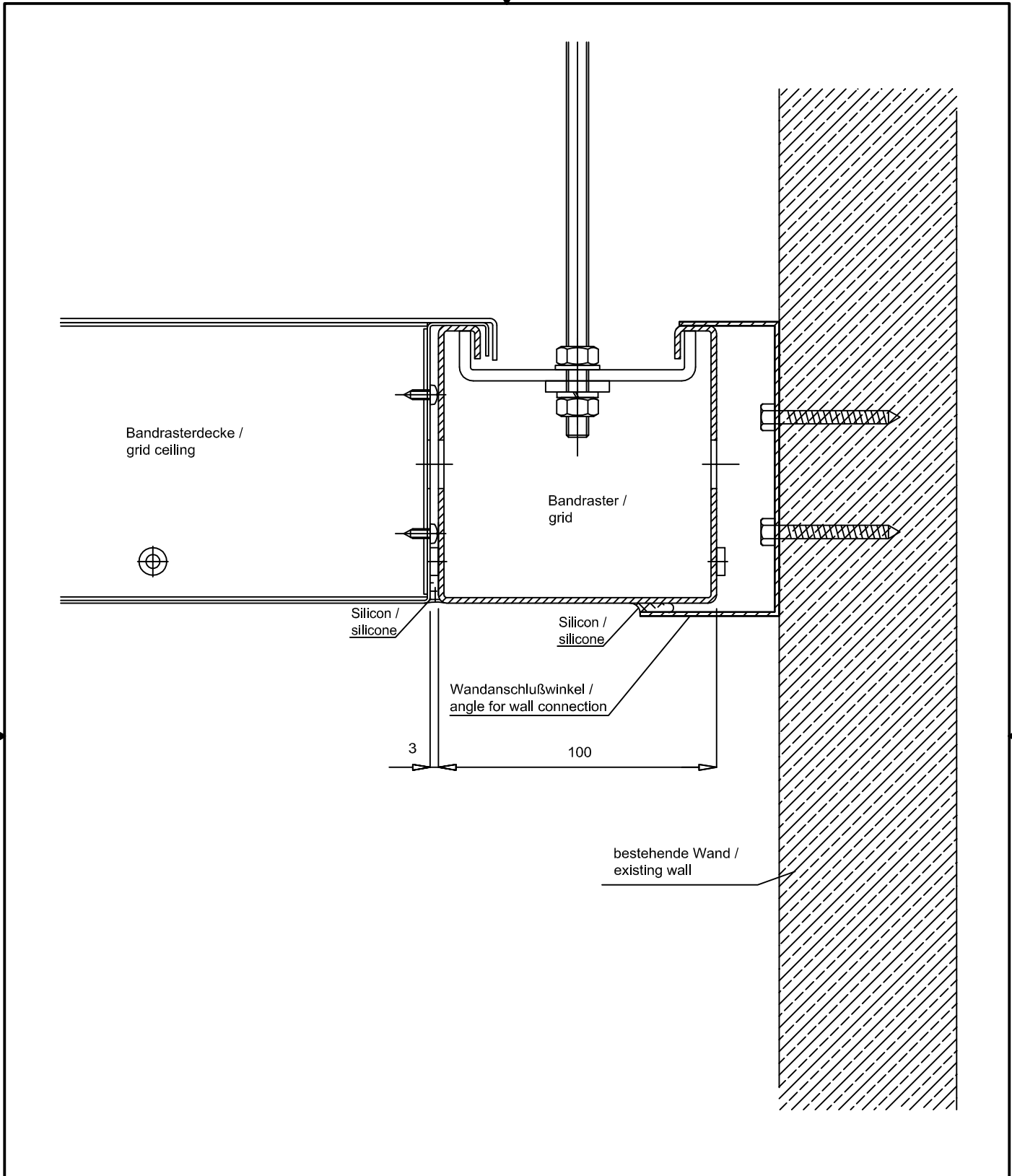

Alle Toleranzen nach DIN ISO 2768 mittel				Material		
This drawing is our literary property and may neither copied nor to be exposed approachable to third persons without our agreement; according to German Copyright Act						
				Datum	Name	Description / Bezeichnung: D 015 C Decken- Wandanschluss mit Wandschale / D 015 C ceiling and wall connection with wall panel
				Gezeichnet	25.07.2014 jk	
				Kontrolliert		
				Norm		
				Projekt Nr.		Z-Nr: VRS_PD1_11_0004
				PRO_XXX		
Status	Änderungen	Datum	Name			1 A4



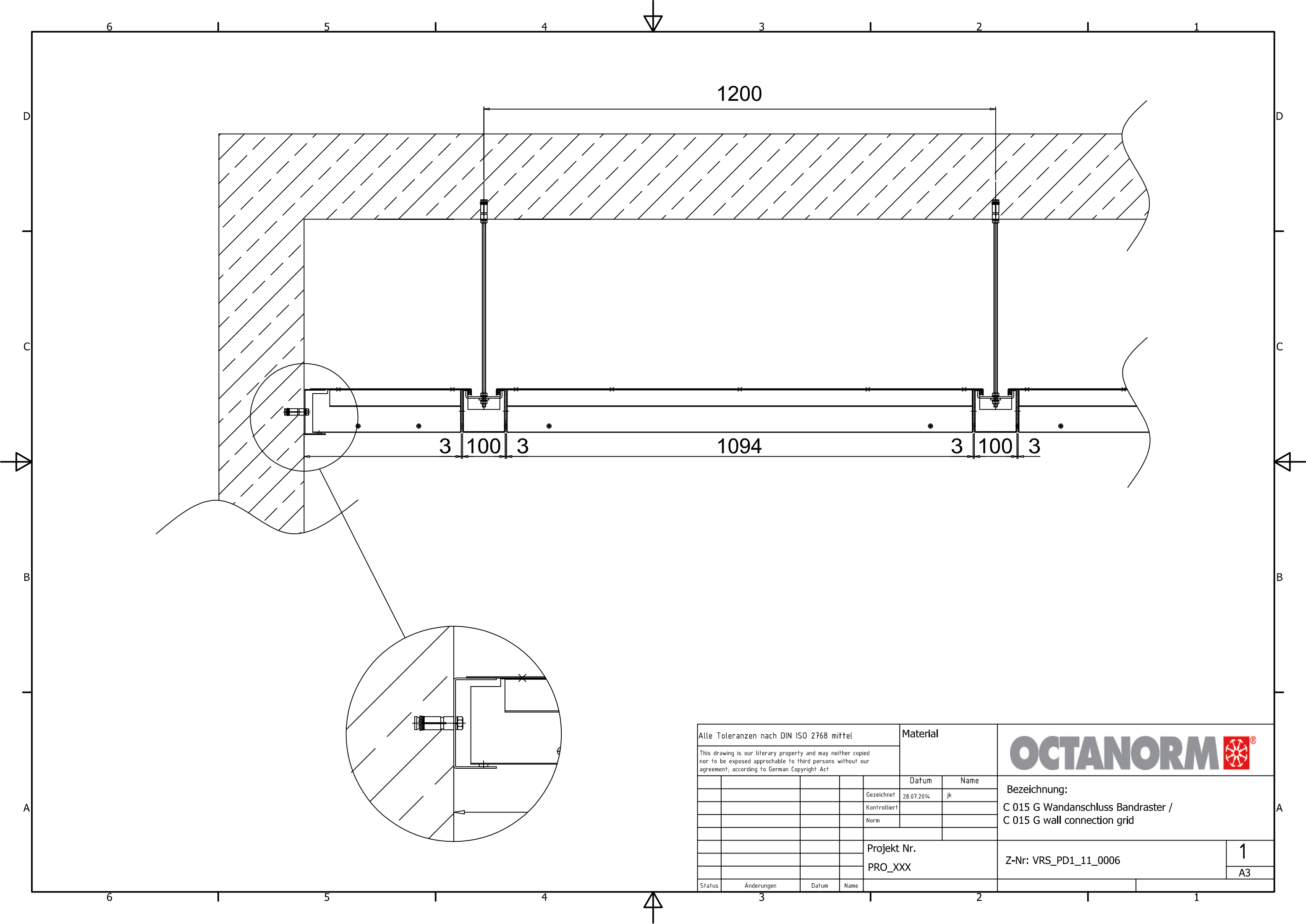

Alle Toleranzen nach DIN ISO 2768 mittel				Material		
This drawing is our literary property and may neither copied nor to be exposed approachable to third persons without our agreement; according to German Copyright Act						
				Datum	Name	Description / Bezeichnung: D 015 E Decken- Wandanschluss / D 015 E ceiling connection and wall connection
				Gezeichnet	25.07.2014 jk	
				Kontrolliert		
				Norm		
				Projekt Nr.		Z-Nr: VRS_PD1_11_0005
				PRO_XXX		
Status	Änderungen	Datum	Name			1 A4



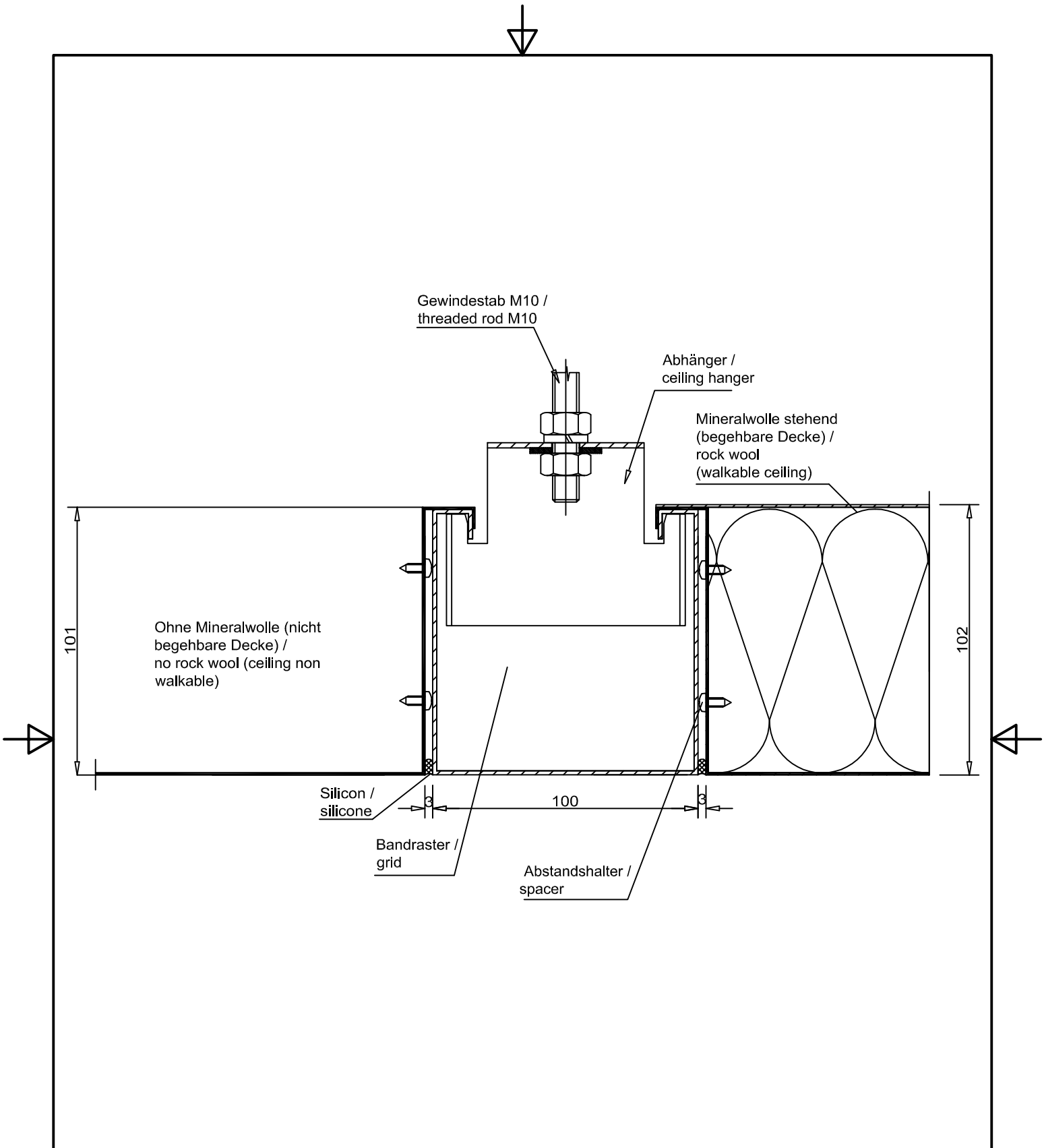

Alle Toleranzen nach DIN ISO 2768 mittel				Material		
This drawing is our literary property and may neither copied nor to be exposed approachable to third persons without our agreement; according to German Copyright Act						
				Datum	Name	Bezeichnung: C 015 G Wandanschluss Bandraster / C 015 G wall connection grid
				Gezeichnet	28.07.2014 jk	
				Kontrolliert		
				Norm		Z-Nr: VRS_PD1_11_0006
				Projekt Nr.	PRO_XXX	
Status	Änderungen	Datum	Name			1 A3



Alle Toleranzen nach DIN ISO 2768 mittel				Material		
This drawing is our literary property and may neither copied nor to be exposed approachable to third persons without our agreement; according to German Copyright Act						
				Datum	Name	Description / Bezeichnung: D 015 F Bandrasterdecke / D 015 F grid ceiling
				Gezeichnet	25.07.2014 jk	
				Kontrolliert		
				Norm		
				Projekt Nr.		Z-Nr: VRS_PD1_12_0001
				PRO_XXX		
Status	Änderungen	Datum	Name			1 A4

# Schnitt A-A / section B-B

halbe begehbare Platte :  
mit Leuchenausschnitt /  
semi walkable plate with  
a gap for lamps

Abdeckung 725x725 /  
covering 725 x 725

635 x 635

Leuchtengehäuse 600 x 600 /  
lamp housing 600 x 600

100

Ausschnitt 606 x 606 /  
gap 606 x 606

3

600

3

244

606

244

3

100

3

1094

3

100

3

1200

1200

Deckenplatte mit Lüftungsausschnitt /  
ceiling plate with a gap for ventilation

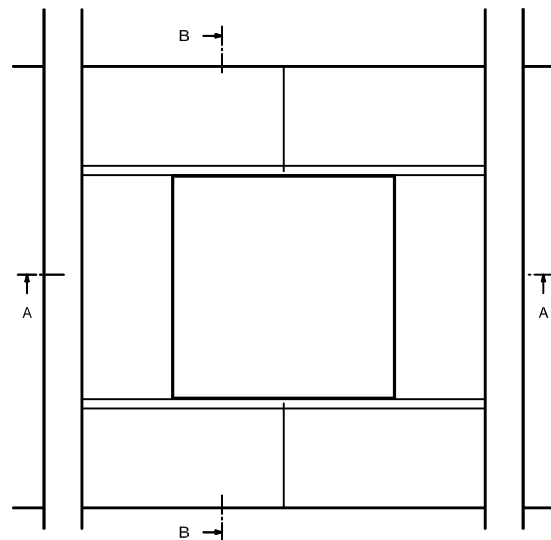

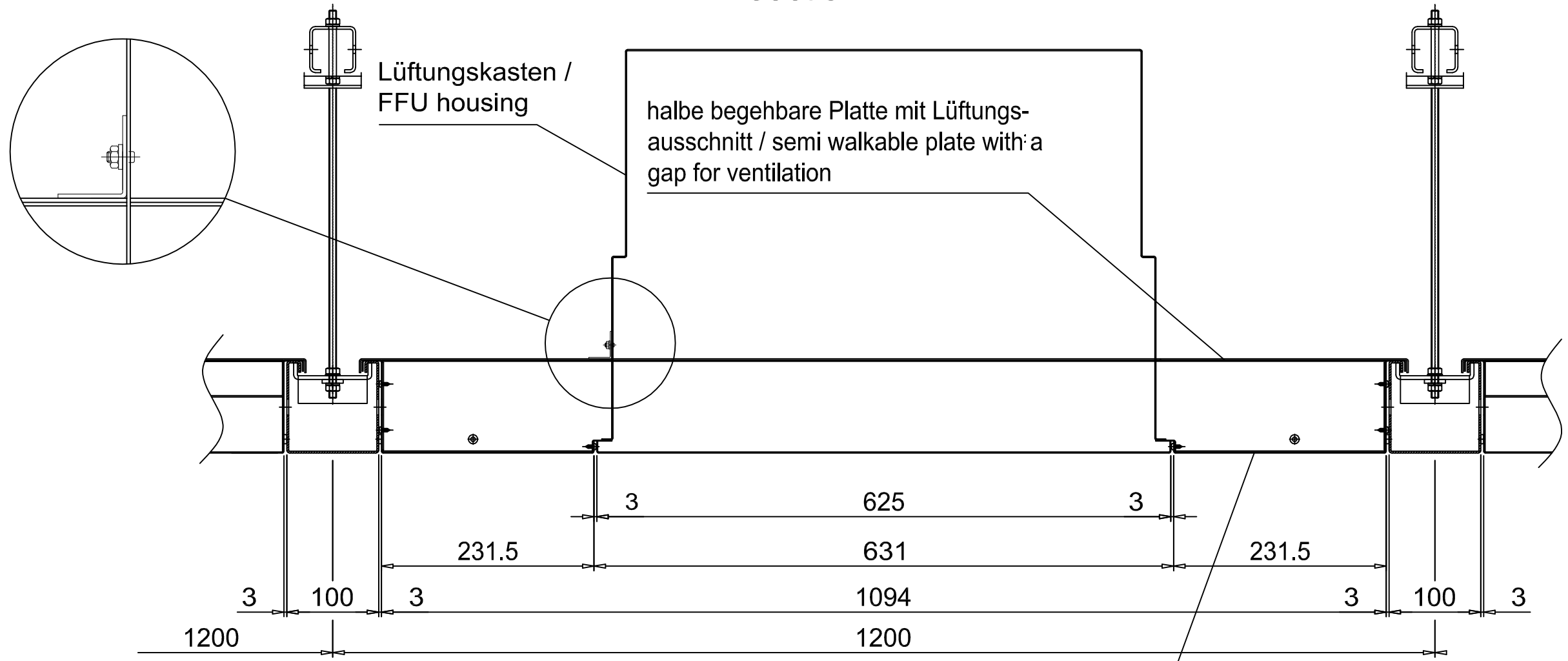

Alle Toleranzen nach DIN ISO 2768 mittel				Material		
This drawing is our literary property and may neither copied nor to be exposed approachable to third persons without our agreement; according to German Copyright Act				Datum	Name	
				Gezeichnet	28.07.2014	jk
				Kontrolliert		
				Norm		
				Projekt Nr.		Bezeichnung: C 015 C Deckenausschnitt mit Leuchte / C 015 C ceiling gap with lamp
				PRO_XXX		
				Z-Nr: VRS_PD1_12_0002		1
						A3
Status	Änderungen	Datum	Name			

Schnitt A-A /  
section A-A

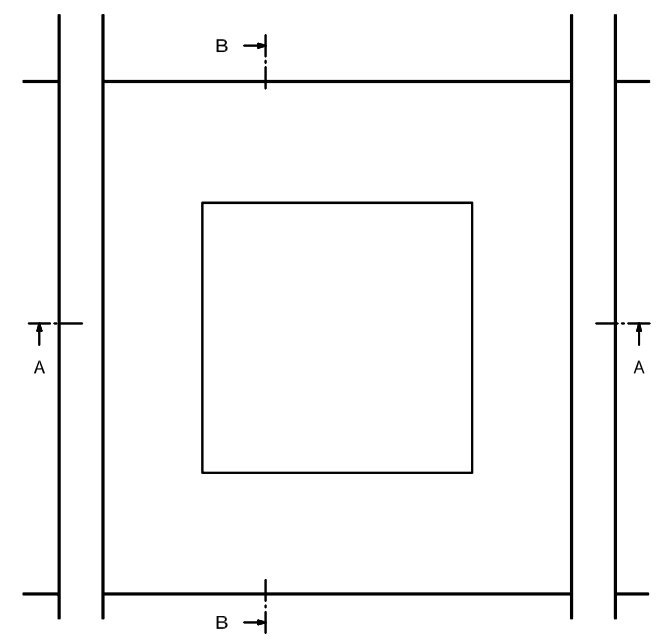

Deckenplatte mit Lüftungsausschnitt /  
ceiling plate with gap for ventilation



Alle Toleranzen nach DIN ISO 2768 mittel				Material		
This drawing is our literary property and may neither copied nor to be exposed approachable to third persons without our agreement; according to German Copyright Act				Datum	Name	
				Gezeichnet	28.07.2014	jk
				Kontrolliert		
				Norm		
				Projekt Nr.		Bezeichnung: C 015 B Deckenausschnitt mit Lüftung / C 015 B ceiling gap with ventilation
				PRO_XXX		
Status	Änderungen	Datum	Name			Z-Nr: VRS_PD1_12_0003
						1
						A3

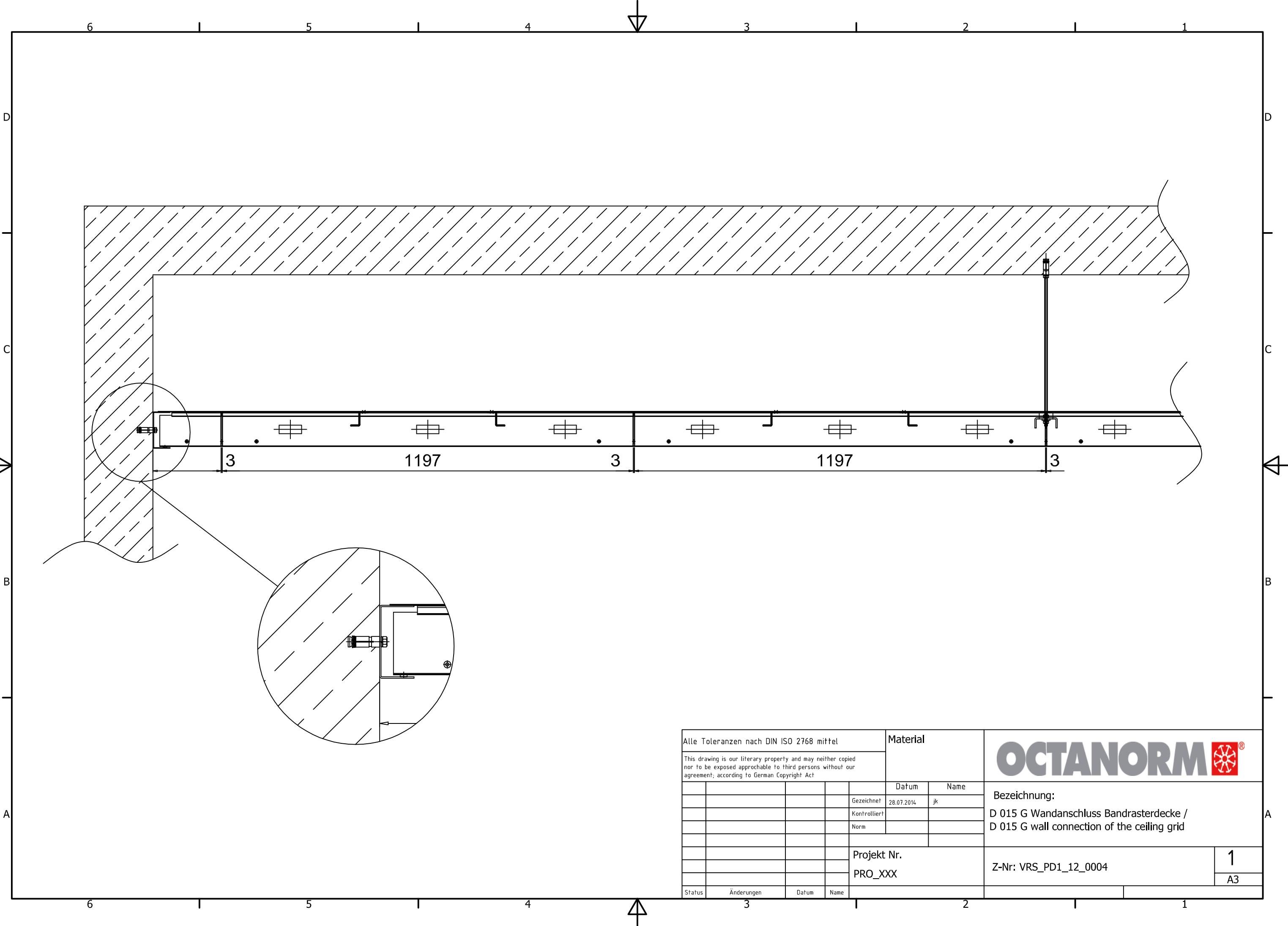

Alle Toleranzen nach DIN ISO 2768 mittel				Material		
This drawing is our literary property and may neither copied nor to be exposed approachable to third persons without our agreement; according to German Copyright Act						
				Datum	Name	Bezeichnung: D 015 G Wandanschluss Bandrasterdecke / D 015 G wall connection of the ceiling grid
				Gezeichnet	28.07.2014 jk	
				Kontrolliert		
				Norm		Z-Nr: VRS_PD1_12_0004
				Projekt Nr.	PRO_XXX	
Status	Änderungen	Datum	Name			1 A3